

ALTAIR[®] 4X MSHA Multigas Detector

Instruction Manual



In North America, to contact your nearest stocking location, dial toll-free 1-800-MSA-2222
To contact MSA International, dial 724-776-8626 or 1-800-MSA-7777.

© MINE SAFETY APPLIANCES COMPANY 2014 - All Rights Reserved
This manual is available on the internet at www.msaSafety.com

Manufactured by
MSA NORTH AMERICA
1000 Cranberry Woods Drive
Cranberry Township, Pennsylvania 16066

(L) Rev 2

10128754

⚠ WARNING

THIS MANUAL MUST BE CAREFULLY READ BY ALL INDIVIDUALS WHO HAVE OR WILL HAVE THE RESPONSIBILITY FOR USING OR SERVICING THE PRODUCT. Like any piece of complex equipment, this instrument will perform as designed only if it is used and serviced in accordance with the manufacturer's instructions. OTHERWISE, IT COULD FAIL TO PERFORM AS DESIGNED AND PERSONS WHO RELY ON THIS PRODUCT FOR THEIR SAFETY COULD SUSTAIN SEVERE PERSONAL INJURY OR DEATH.

The warranties made by Mine Safety Appliances Company with respect to the product are voided if the product is not used and serviced in accordance with the instructions in this manual. Please protect yourself and others by following them. We encourage our customers to write or call regarding this equipment prior to use or for any additional information relative to use or repairs.

1. Instrument Safety	1-1
1.1. Correct Use	1-1
1.2. Safety and Precautionary Measures	1-3
Observe proper battery maintenance	1-5
Be aware of environmental conditions	1-5
Be aware of the procedures	
for handling electrostatically sensitive electronics	1-5
Be aware of the product regulations	1-5
Be aware of the warranty regulations	1-5
1.3. Warranty	1-5
1.3.1 Warranty	1-5
1.3.2 Exclusive Remedy	1-6
1.3.3 Exclusion of Consequential Damage	1-6
2. Description	2-1
2.1. Instrument Overview	2-1
Figure 2-1. Instrument View	2-1
2.2 Device Hardware Interfaces	2-2
2.2.1 Button Definitions	2-2
2.2.2 LED Definitions	2-2
2.2.3 Vibrating Alarm	2-3
2.2.4 Backlight	2-3
2.2.5 Horn	2-3
2.2.6 On-Screen Indicators	2-4
Figure 2-2. Display and Graphic Symbols	2-4
2.2.7 Battery Life Indicator	2-5
Battery Warning	2-5
Battery Shutdown	2-6
Battery Charging	2-6
To Charge the Instrument	2-7
2.2.8 Operating Beep	2-7
2.3 Viewing Optional Displays	2-7
2.3.1 Bump Mode	2-7
2.3.2 Peak Readings (PEAK page)	2-8
2.3.3 Minimum Readings (MIN page)	2-8
2.3.4 Short Term Exposure Limits (STEL page)	2-8
STEL calculation examples:	2-9
2.3.5 Time Weighted Average (TWA Page)	2-9

To Reset the TWA Readings	2-9
TWA Calculation Examples:	2-10
2.3.6 Time Display	2-10
2.3.7 Date Display	2-10
2.3.8 Last Cal Page	2-10
2.3.9 Cal Due Page	2-10
2.3.10 Motion Alert Page	2-10
2.4 Sensor Missing Alarm	2-11
2.5 Sensor Life Warning	2-11
2.6 Sensor Life Indicator	2-11
2.7 Monitoring Toxic Gases	2-11
2.8 Monitoring Oxygen Concentration	2-12
2.9 Monitoring Combustible Gases	2-13

3. Operation **3-1**

3.1. Environmental Factors	3-1
Pressure Changes	3-1
Humidity Changes	3-1
Temperature Changes	3-1
3.2. Turning ON and Fresh Air Setup	3-2
3.2.1 Screen Displays during Startup	3-3
Instrument Self Test	3-3
Instrument Name and Software version	3-3
Combustible Gas Type	3-3
Toxic Gas Units	3-3
Alarm Setpoints	3-4
STEL and TWA Setpoints	3-4
Calibration Values	3-4
Time and Date	3-4
Last CAL Date and CAL Due	3-5
Fresh Air Setup (FAS)	3-5
3.2.2 Fresh Air Setup (FAS)	3-5
3.3. Measurement Mode (Normal Operation)	3-6
Bump Page	3-6
Figure 3-1. Fresh Air Setup	3-6
Peak Page	3-7
Min Page	3-7
STEL Page	3-7

TWA Page	3-7
Time / Date Page	3-7
Motion Alert	3-8
3.4 Instrument Setup	3-8
3.4.1 Sensor Setup	3-9
Figure 3-2. Sensor Setup	3-9
3.4.2 Calibration Setup	3-10
3.4.3 Alarm Setup	3-10
Figure 3-3. Calibration Setup	3-10
Figure 3-4. Alarm Setup	3-11
3.4.4 Setup Time and Date	3-12
3.5 Data Logging	3-12
Connecting Instrument to PC	3-12
Figure 3-5. Date and Time Setup	3-12
3.6 Function Tests on the Instrument	3-13
Alarm Test	3-13
3.7 Safe LED	3-13
3.8 Calibration Check	3-13
3.8.1 Equipment.	3-14
3.8.2 Performing a Calibration Check	3-14
3.9 Calibration	3-16
3.9.1 Fresh Air Setup and Zero Calibration	3-16
3.9.2 Span Calibration	3-17
3.9.3 Finishing Calibration	3-19
4. Maintenance	4-1
4.1 Troubleshooting	4-2
4.2 Live Maintenance Procedure - Replacing and Adding a Sensor	4-3
4.3 Cleaning the Instrument	4-5
4.4 Storage	4-5
4.5 Shipment	4-5

5. Technical Specifications/Certifications . . .5-1

5.1 Technical Specifications5-1
5.2 Factory-set Alarm Thresholds and Setpoints5-2
5.3 Certifications5-2
Performance Specification5-2
5.4.1 Combustible Gas5-2
5.4.2 Oxygen5-3
5.4.3 Carbon Monoxide5-3
5.4.4 Hydrogen Sulfide5-4
5.4.5 Nitrogen Dioxide5-4
5.5 XCell® Sensor Patents5-5

6. Order Information6-1

7. Appendix – Flow Charts7-1

7.1. Start Up Sequence (Power ON)7-1
7.2 Fresh Air Setup7-2
7.3 Reset Screen Controls7-3
7.4 Calibrations7-5
7.5 Options Setup7-6
7.6 Sensor Setup7-7
7.7 Alarm Setup7-8
7.8 Time and Date Setup7-9

1. Instrument Safety

1.1. Correct Use

The ALTAIR 4X Multigas Detector is for use by trained and qualified personnel. It is designed to be used when performing a hazard assessment to:

- Assess potential worker exposure to combustible and toxic gases and vapors as well as low level of oxygen.
- Determine the appropriate gas and vapor monitoring needed for a workplace.

The ALTAIR 4X Multigas Detector can be equipped to detect:

- Combustible gases and certain combustible vapors
- Oxygen-deficient or oxygen-rich atmospheres
- Specific toxic gases for which a sensor is installed.

⚠ WARNING

Read and follow all instructions carefully.

- **Perform a calibration check before each day's use and adjust if necessary.**
- **Perform a calibration check more frequently if exposed to silicone, silicates, lead-containing compounds, hydrogen sulfide, or high contaminant levels.**
- **Recheck calibration if unit is subjected to physical shock.**
- **Use only to detect gases/vapors for which a sensor is installed.**
- **Do not use to detect combustible dusts or mists.**
- **Make sure adequate oxygen is present for accurate combustible readings (>10% O₂).**
- **Do not block sensors.**
- **Have a trained and qualified person interpret instrument readings.**

- **Do not recharge Li ION battery in a combustible atmosphere.**
- **Do not alter or modify instrument.**

INCORRECT USE CAN CAUSE SERIOUS PERSONAL INJURY OR DEATH.

NOTE: This equipment has been tested and found to comply with the limits for a Class A digital device, pursuant to part 15 of the FCC Rules. These limits are designed to provide reasonable protection against harmful interference when the equipment is operated in a commercial environment. This equipment generates, uses, and can radiate radio frequency energy and, if not installed and used in accordance with the instruction manual, may cause harmful interference to radio communications. Operation of this equipment in a residential area is likely to cause harmful interference in which case the user will be required to correct the interference at his own expense.

⚠ WARNING

This is a class A product. In a domestic environment, this product may cause radio interference in which case the user may be required to take adequate measures.

1.2. Safety and Precautionary Measures

⚠ WARNING

Carefully review the following safety limitations and precautions before placing this instrument in service. Incorrect use can cause serious personal injury or death.

- Check function (see section 3.6) each day before use. MSA recommends carrying out a routine inspection prior to each day's use.
- Perform a Calibration Check (see section 3.8) before each day's use to verify proper instrument operation. The instrument must pass the Calibration Check. If it fails the test, perform a calibration (see section 3.9) before using the instrument.
- Perform a Calibration Check more frequently if the unit is subjected to physical shock or high levels of contaminants. Also, perform a Calibration Check more frequently if the tested atmosphere contains the following materials, which may desensitize the combustible gas sensor and reduce its readings:
 - Organic silicones
 - Silicates
 - Lead-containing compounds
 - Hydrogen sulfide exposures over 200 ppm or exposures over 50 ppm for one minute.
- The minimum concentration of a combustible gas in air that can ignite is defined as the Lower Explosive Limit (LEL). A combustible gas reading of "XXX" indicates the atmosphere is above 100 % LEL or 5.00 %vol CH₄, and an explosion hazard exists. Move away from hazardous area immediately.
- Do not use the ALTAIR 4X Multigas Detector to test for combustible or toxic gases in the following atmospheres as this may result in erroneous readings:
 - Oxygen-deficient or oxygen-rich atmospheres
 - Reducing atmospheres
 - Furnace stacks
 - Inert environments

- Do not use the ALTAIR 4X Multigas Detector to test for combustible gases in atmospheres containing vapors from liquids with a high flash point (above 38°C, 100°F) as this may result in erroneously low readings.
- Do not block sensor openings as this may cause inaccurate readings. Do not press on the face of the sensors, as this may damage them and cause erroneous readings. Do not use compressed air to clean the sensor holes, as the pressure may damage the sensors.
- Allow sufficient time for unit to display accurate reading. Response times vary based on the type of sensor being utilized (see Section 5.4, "Performance Specifications").
- All instrument readings and information must be interpreted by someone trained and qualified in interpreting instrument readings in relation to the specific environment, industrial practice and exposure limitations.
- Use of the Galaxy™ or GALAXY GX2 Automated Test System is an alternate MSHA-approved method for calibrating MSHA-approved ALTAIR 4X instruments.
- Use only calibration gas that is 2.5% Methane with an accuracy of $\pm 5\%$ when calibrating MSHA-approved ALTAIR 4X instruments.
- The maximum acceptable user-set (password protected) Galaxy Automated Test System tolerance on Bump Limits must be set to 10% or less when calibrating MSHA-approved ALTAIR 4X instruments.
- GALAXY GX2 Automated Test System Test Setup Mode must be set to Calibration Only or Calibration Check/Cal on Fail when calibrating MSHA-approved ALTAIR 4X instruments.
- For 30 CFR Part 75 determinations, the maximum acceptable user-set (password protected) Galaxy Automated Test System tolerance on Bump Limits must only be set to such that 19.5% oxygen can be detected with an accuracy of $\pm 0.5\%$ when calibrating MSHA-approved ALTAIR 4X instruments.
- For 30 CFR Part 75 determinations, the Galaxy GX2 Automated Test System Test Setup Mode must be set to Calibration Only or Calibration Check/Cal on Fail so that 19.5% oxygen can be detected with an accuracy of $\pm 0.5\%$ when calibrating MSHA-approved ALTAIR 4X instruments.

Risk of explosion: Do not recharge instrument in hazardous area.

Observe proper battery maintenance

Use only battery chargers made available by MSA for use with this instrument; other chargers may damage the battery pack and the unit. Dispose of in accordance with local health and safety regulations. Use of the Galaxy or GALAXY GX2 Automated Test System is an alternate approved method for charging ALTAIR 4X instruments

Be aware of environmental conditions

A number of environmental factors may affect the sensor readings, including changes in pressure, humidity and temperature.

Pressure and humidity changes also affect the amount of oxygen actually present in the atmosphere.

Be aware of the procedures for handling electrostatically sensitive electronics

The instrument contains electrostatically sensitive components. Do not open or repair the unit without using appropriate electrostatic discharge (ESD) protection. The warranty does not cover damage caused by electrostatic discharges.

Be aware of the product regulations

Follow all relevant national regulations applicable in the country of use.

Be aware of the warranty regulations

The warranties made by Mine Safety Appliances Company with respect to the product are voided if the product is not used and maintained in accordance with the instructions in this manual. Please protect yourself and others by following them. We encourage our customers to write or call regarding this equipment prior to use or for any additional information relative to use or service.

1.3. Warranty

ITEM	WARRANTY PERIOD
Chassis and electronics	Three years
All sensors unless otherwise specified	Three years

1.3.1 Warranty

This warranty does not cover filters, fuses, etc. Certain other accessories not specifically listed here may have different warranty periods. This warranty is valid only if the product is maintained and used in accordance with Seller's instructions and/or recommendations.

The Seller shall be released from all obligations under this warranty in the event repairs or modifications are made by persons other than its own or authorized service personnel or if the warranty claim results from physical abuse or misuse of the product. No agent, employee or representative of the Seller has any authority to bind the Seller to any affirmation, representation or warranty concerning this product. Seller makes no warranty concerning components or accessories not manufactured by the Seller, but will pass on to the Purchaser all warranties of manufacturers of such components.

THIS WARRANTY IS IN LIEU OF ALL OTHER WARRANTIES, EXPRESSED, IMPLIED OR STATUTORY, AND IS STRICTLY LIMITED TO THE TERMS HEREOF. SELLER SPECIFICALLY DISCLAIMS ANY WARRANTY OF MERCHANTABILITY OR OF FITNESS FOR A PARTICULAR PURPOSE.

1.3.2 Exclusive Remedy

It is expressly agreed that Purchaser's sole and exclusive remedy for breach of the above warranty, for any tortious conduct of Seller, or for any other cause of action, shall be the replacement at Seller's option, of any equipment or parts thereof, which after examination by Seller is proven to be defective.

Replacement equipment and/or parts will be provided at no cost to Purchaser, F.O.B. Seller's Plant. Failure of Seller to successfully replace any nonconforming equipment or parts shall not cause the remedy established hereby to fail of its essential purpose.

1.3.3 Exclusion of Consequential Damage

Purchaser specifically understands and agrees that under no circumstances will seller be liable to purchaser for economic, special, incidental or consequential damages or losses of any kind whatsoever, including but not limited to, loss of anticipated profits and any other loss caused by reason of nonoperation of the goods. This exclusion is applicable to claims for breach of warranty, tortious conduct or any other cause of action against seller.

2. Description

2.1. Instrument Overview

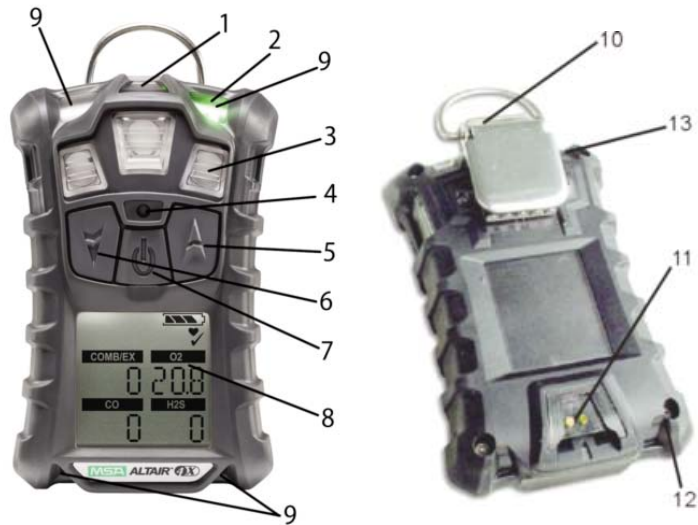

- | | | | |
|---|---|----|------------------------|
| 1 | MSA Link Communication | 8 | Display |
| 2 | Safe LED (green) and Fault LED (yellow) | 9 | Alarm LEDs (4) |
| 3 | Sensor Inlets | 10 | Clip |
| 4 | Horn | 11 | Charging Connection |
| 5 | ▲ Button | 12 | Screws (4) |
| 6 | ▼ Button | 13 | Charge LED (red/green) |
| 7 | ⊕ Button | | |

Figure 2-1. Instrument View

The instrument monitors gases in ambient air and in the workplace.

The ALTAIR 4X is available with a maximum of three sensors, which can display readings for four separate gases (one Two Toxic Sensor provides both CO and NO₂ sensing capabilities in a single sensor).

The alarm levels for the individual gases are factory-set and can be changed through the instrument Setup Menu. These changes can also be made through MSA Link™ Software. Ensure that the latest version of the MSA Link software has been downloaded from MSA's website www.MSAafety.com.

If gas is present during Fresh Air Setup, the instrument will fail and enter Measure mode.

2.2 Device Hardware Interfaces

Instrument operation is dialog driven from the display with the aid of the three function buttons (see FIGURE 2-1).

2.2.1 Button Definitions

BUTTON	DESCRIPTION
⊕	The ⊕ Button is used to turn instrument ON or OFF and to confirm user action selections. When the ▲ button and the ⊕ button are pressed simultaneously at instrument start-up, the Options Setup mode displays.
▼	The ▼ Button is used to page down through data screens in measuring mode or as a page back and to decrease the values in Setup mode. Holding this button for 3 seconds while in Normal Measure mode activates the InstantAlert™ alarm.
▲	The ▲ button is used to reset peak, STEL TWA and acknowledge alarms (where possible) or access calibration in Measuring mode. It is also used as page up or to increase the values in Setup mode.

2.2.2 LED Definitions

LED	DESCRIPTION
GREEN	The Safe LED flashes once every 15 seconds to notify the user that the instrument is ON and operating under the conditions defined in Section 3.7. This option can be turned OFF through the MSA Link software
RED	The Alarm LEDs are visual indications of an alarm condition or any type of error in the instrument
YELLOW	The yellow LED is a visual indication of an instrument fault condition. This LED turns ON with the following conditions: <ul style="list-style-type: none">• Instrument memory error• Sensor Missing• Sensor Error
RED / GREEN	The Charge LED is a visual indication of charge status. Red indicates the instrument is charging Green indicates the charge is complete

2.2.3 Vibrating Alarm

The instrument is equipped with a vibrating alarm.

2.2.4 Backlight

The backlight automatically activates when any front panel button is pressed and remains ON for the duration of user-selected timeout. This ON/OFF duration can be changed through MSA Link software.

2.2.5 Horn

The horn provides an audible alarm.

2.2.6 On-Screen Indicators

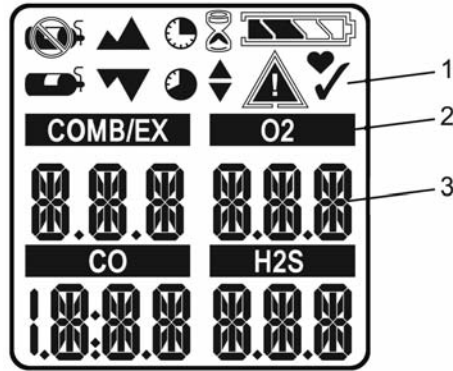

- 1 Graphic Symbols
- 2 Gas Type
- 3 Gas Concentration

	Alarm Symbol – Indicates alarm state		No Gas Cylinder – Indicates cal gas should not be applied and instrument must be exposed to fresh air
	Bump Check Symbol – Indicates successful bump or cal		Hourglass – Indicates user should wait
	Indicates required interaction		Minimum – Indicates a minimum value or low alarm
	Battery Condition – Indicates the battery charge level		PEAK Symbol – Indicates a PEAK reading or high alarm
	Sensor Labels		STEL Symbol – Indicates a STEL alarm
	Motion Alert™ – Indicates Motion Alert is active		TWA Symbol – Indicates a TWA alarm
	Cal Gas Cylinder – Indicates cal gas must be applied		End of Sensor Life Warning/Indicator

Figure 2-2. Display and Graphic Symbols

2.2.7 Battery Life Indicator

The battery condition icon continuously displays in the upper right-hand corner of the color display. As the battery is depleted, battery icon segments blank until only the battery icon outline remains.

Each indicator segment represents approximately 25% of the total battery capacity.

Battery Warning

⚠ WARNING

If battery warning alarm activates while using the instrument, leave the area immediately as the end of battery life is approaching.

Failure to follow this warning can result in serious personal injury or death.

The nominal run-time of the instrument at room temperature is 34 hours. Actual run-time will vary depending on ambient temperature, Alarm conditions, and age of battery. Instrument run-time at -4°F (-20°C) is approximately 20 hours.

A Low Battery Warning indicates that a nominal 30 minutes of operation remain before the battery's charge is depleted.

The duration of remaining instrument operation during a Low Battery Warning depends on ambient temperatures.

When the instrument goes into Low Battery Warning, the:

- battery life indicator flashes
- alarm sounds
- alarm LEDs flash
- display flashes "LOW BATT" and 
- instrument repeats this warning every 60 seconds and continues to operate until it is turned OFF or battery shutdown occurs

Battery Shutdown

⚠ WARNING

If the battery shutdown alarm activates, stop using the instrument as it no longer has enough power to indicate potential hazards, and persons relying on this product for their safety could sustain serious personal injury or death.

The instrument goes into battery shutdown mode 60 seconds before final shutdown (when the batteries can no longer operate the instrument):

- "BATT ALARM" and  flash on the display
- Alarm sounds and lights flash; alarm cannot be silenced
- No other pages can be viewed; after approximately one minute, the instrument automatically turns OFF.

When battery shutdown condition occurs:

1. Leave the area immediately.
2. Recharge or replace the battery pack.

Battery Charging

⚠ WARNING

Risk of explosion: Do not recharge instrument in hazardous area.

⚠ CAUTION



Use of any charger, other than the Charger supplied with the instrument, may damage or improperly charge the batteries.

- The charger is capable of charging a completely depleted pack in less than four hours in normal, room-temperature environments.

NOTE: Allow very hot or cold instruments to stabilize for one hour at room temperature before attempting to charge.

- Minimum and maximum ambient temperature to charge the instrument is 10°C (50°F) and 35°C (95°F), respectively.
- For best results, charge the instrument at room temperature (23°C).

To Charge the Instrument

- Firmly insert the charger connector into the charge port on the back of the instrument.
- The battery symbol  scrolls through a progressively increasing number of segments and the charge LED is red until 90% of full charge is obtained. Then,  remains fully illuminated and the charge LED turns green while the battery is trickle charged to its full capacity.
- If a problem is detected during charging, the battery symbol flashes and the charge LED is orange. Disconnect the charger momentarily to reset the charge cycle.

2.2.8 Operating Beep

This operating beep activates every 30 seconds by momentarily beeping the horn and flashing the alarm LEDs under the following conditions:

- Operating beep is enabled
- Instrument is on normal Measure Gases page
- Instrument is not in battery warning
- Instrument is not in gas alarm
- Audible and visual options are enabled

2.3 Viewing Optional Displays

The Main Screen appears at instrument turn-ON.

Optional displays can be viewed by pressing the ▼ button to move to:

2.3.1 Bump Mode

To select the Bump mode, press the ⬤ button

To move forward, press the ▼ button.

To move backward to the Main page, press the ▲ button.

2.3.2 Peak Readings (PEAK page)

The peak icon ▲ shows the highest levels of gas recorded by the instrument since turn-ON or since peak readings were reset.

To reset the peak readings:

1. Access the PEAK page.
2. Press the ▲ button.

2.3.3 Minimum Readings (MIN page)

This page shows the lowest level of oxygen recorded by the instrument since turn-ON or since the MIN reading was reset.

The minimum icon ▼ appears on the display

To reset the MIN readings:

1. Access the MIN page.
2. Press the ▲ button.

2.3.4 Short Term Exposure Limits (STEL page)

⚠ WARNING

If the STEL alarm activates, leave the contaminated area immediately; the ambient gas concentration has reached the preset STEL alarm level. Failure to follow this warning will cause over-exposure to toxic gases and persons relying on this product for their safety could sustain serious personal injury or death.

The STEL icon ● appears on the display to show the average exposure over a 15-minute period.

When the amount of gas detected by the instrument is greater than the STEL limit:

- Alarm sounds
- Alarm LEDs flash
- STEL icon flashes.

To reset the STEL:

1. Access the STEL page.

2. Press the ▲ button.

The STEL alarm is calculated over a 15-minute exposure.

STEL calculation examples:

Assume the instrument has been running for at least 15 minutes:

- **15-minute exposure of 35 ppm:**

$$\frac{(15 \text{ minutes} \times 35 \text{ PPM})}{15 \text{ minutes}} = 35 \text{ PPM}$$

- **10-minute exposure of 35 ppm and
5 minute-exposure of 15 ppm:**

$$\frac{(10 \text{ minutes} \times 35 \text{ PPM}) + (5 \text{ minutes} \times 15 \text{ PPM})}{15 \text{ minutes}} = 25 \text{ PPM}$$

This page can be de-activated through MSA Link.

2.3.5 Time Weighted Average (TWA Page)

⚠ WARNING

If the TWA alarm activates, leave the contaminated area immediately; the ambient gas concentration has reached the preset TWA alarm level. Failure to follow this warning will cause over-exposure to toxic gases and persons relying on this product for their safety could sustain serious personal injury or death.

The TWA icon  appears on the display to show the average exposure since the instrument was turned ON or since the TWA reading was reset. When the amount of gas detected is greater than the eight-hour TWA limit:

- alarm sounds
- alarm lights flash
- TWA icon flashes.

To Reset the TWA Readings

1. Access the TWA Page.
2. Press the ▲ button.

The TWA alarm is calculated over an eight-hour exposure.

TWA Calculation Examples:

- **1-hour exposure of 50 ppm:**

$$\frac{(1 \text{ hour} \times 50 \text{ PPM}) + (7 \text{ hours} \times 0 \text{ PPM})}{8 \text{ hours}} = 6.25 \text{ PPM}$$

- **4-hour exposure of 50 ppm and
4-hour exposure of 100 ppm:**

$$\frac{(4 \text{ hours} \times 50 \text{ PPM}) + (4 \text{ hours} \times 100 \text{ PPM})}{8 \text{ hours}} = 75 \text{ PPM}$$

- **12-hour exposure of 100 ppm:**

$$\frac{(12 \text{ hours} \times 100 \text{ PPM})}{8 \text{ hours}} = 150 \text{ PPM}$$

2.3.6 Time Display

Current time appears on the display in a 12-hour format by default.

A 24-hour format can be selected using MSA Link.

2.3.7 Date Display

Current date appears on the display in the format: MM-DD-YYYY.

2.3.8 Last Cal Page

Displays the instrument's last successful calibration date in the format: MM-DD-YYYY.

2.3.9 Cal Due Page

Displays the days until the instrument's next calibration is due (user selectable).

2.3.10 Motion Alert Page

To activate or deactivate the Motion Alert feature, press the ▲ button while the Motion Alert Activation page is displayed. When the Motion Alert feature is active, the △ symbol flashes every 3 seconds. The instrument enters pre-alarm when no motion is detected for 20 seconds. This condition can be cleared by moving the instrument.

After 30 seconds of inactivity, the full Motion Alert alarm is triggered. This alarm can only be cleared by pressing the ▲ button

2.4 Sensor Missing Alarm

The instrument enters the Sensor Missing alarm if the instrument detects that a sensor is not properly installed in the instrument.

If a sensor is detected as missing, the following occurs:

- "SENSOR ERROR" displays
- The flag above the sensor detected as missing flashes on the display
- Alarm sounds and lights flash
- Yellow Fault LED is on solid
- If there is a sensor error at startup, the instrument shuts OFF in 60 seconds.

2.5 Sensor Life Warning

If a sensor is nearing its end of life, the instrument warns the user following a sensor calibration. While the sensor is still fully functional at this point, the warning gives the user time to plan for a replacement sensor and minimize downtime. The ♥ is continuously displayed. See calibration section 3.9 for more details.

2.6 Sensor Life Indicator

If the instrument cannot calibrate one or more sensors, the instrument displays "Span" "Err" followed by the ▲ and ♥ to indicate end of sensor life. See calibration section 3.9 for more details.

2.7 Monitoring Toxic Gases

The instrument can monitor the concentration of the following toxic gases in ambient air:

- Carbon Monoxide (CO)
- Nitrogen Dioxide (NO₂)
- Hydrogen Sulfide (H₂S).

The instrument displays the gas concentration in parts per million (PPM) or mg/m³ on the Measuring page until another page is selected or the instrument is turned OFF.

▲ WARNING

If an alarm activates while using the instrument, leave the area immediately.

Remaining in the area under such circumstances can cause serious personal injury or death.

The instrument has four gas alarms for each toxic gas:

- HIGH Alarm
- LOW Alarm
- STEL Alarm
- TWA Alarm.

If the gas concentration reaches or exceeds the alarm setpoint, the instrument:

- backlight turns ON
- a vibrating alarm triggers
- displays and flashes the Alarm icon ▲ and either the Minimum icon ▼ (LOW alarm) or the Maximum icon ▲▲ (HIGH alarm)
- enters an alarm state.

2.8 Monitoring Oxygen Concentration

The instrument monitors oxygen concentration in ambient air. The alarm setpoints can be set to activate on two different conditions:

- Enriched - oxygen concentration > 20.8 % or
- Deficient - oxygen concentration < 19.5 %.

▲ WARNING

If an alarm activates while using the instrument, leave the area immediately.

Remaining in the area under such circumstances can cause serious personal injury or death.

When the alarm setpoint is reached for either of the above conditions:

- an alarm sounds
- alarm LEDs flash
- a vibrating alarm triggers

- instrument displays and flashes the Alarm icon ▲ and either the Minimum icon ▼ (Enriched alarm) or the Maximum icon ▲▲ (Deficient alarm) along with the corresponding oxygen concentration.

The LOW alarm (oxygen deficient) is latching and will not automatically reset when the O₂ concentration rises above the LOW setpoint. To reset the alarm, press the ▲ button. If the alarm condition still exists, the ▲ button only silences the alarm for five seconds.

False oxygen alarms can occur due to changes in barometric pressure (altitude) or extreme changes in ambient temperature.

It is recommended that an oxygen calibration be performed at the temperature and pressure of use. Be sure that the instrument is in known fresh air before performing a calibration.

2.9 Monitoring Combustible Gases

The instrument displays the combustible gas concentration in %LEL or %CH₄ on the Measuring page until another page is selected or the instrument is turned OFF.

▲ WARNING

If an alarm activates while using the instrument, leave the area immediately.

Remaining in the area under such circumstances can cause serious personal injury or death.

The instrument has two alarm setpoints:

- HIGH Alarm
- LOW Alarm.

If the gas concentration reaches or exceeds the alarm setpoint, the instrument:

- backlight turns ON
- a vibrating alarm triggers
- displays and flashes the alarm icon ▲ and either the minimum icon ▼ (LOW alarm) or the maximum icon ▲▲ (HIGH alarm)
- enters an alarm state.

When gas reading reaches 100% LEL or 5.00% CH₄, the instrument enters a Lock Alarm state, the combustible sensor shuts down and displays "xxx" in place of the actual reading. This state can only be reset by turning the instrument OFF and ON in a fresh air environment.

⚠ WARNING

A combustible gas reading of "100" or "5.00" indicates the atmosphere is above 100% LEL or 5.00% vol CH₄, respectively, and an explosion hazard exists. Move away from contaminated area immediately.

In such cases, the instrument LockAlarm feature activates.

3. Operation

Instrument operation is dialog driven from the display with the aid of the three Function buttons (see Section 2).

3.1. Environmental Factors

A number of environmental factors may affect the gas sensor readings, including changes in pressure, humidity and temperature. Pressure and humidity changes affect the amount of oxygen actually present in the atmosphere.

Pressure Changes

If pressure changes rapidly (e.g., stepping through airlock) the oxygen sensor reading may temporarily shift, and possibly cause the detector to go into alarm. While the percentage of oxygen may remain at or near 20.8 vol%, the total amount of oxygen present in the atmosphere available for respiration may become a hazard if the overall pressure is reduced by a significant degree.

Humidity Changes

If humidity changes by any significant degree (e.g., going from a dry, air conditioned environment to outdoor, moisture laden air), oxygen readings can be reduced by up to 0.5 %, due to water vapor in the air displacing oxygen.

The oxygen sensor has a special filter to reduce the effects of humidity changes on oxygen readings. This effect will not be noticed immediately, but slowly impacts oxygen readings over several hours.

Temperature Changes

The sensors have built-in temperature compensation. However, if temperature shifts dramatically, the sensor reading may shift. Zero the instrument at the work site temperature for the least effect.

3.2. Turning ON and Fresh Air Setup

Instrument operation is dialog driven from the display with the aid of the three Function buttons (see Section 2.2.1). For more information, see the flow charts in Section 7.





Turn the instrument ON with the  button.

The instrument performs a self test and then goes to Fresh Air Setup:

- all display segments are activated
- audible alarm sounds
- alarm LEDs light
- vibrating alarm is activated.

During the self test, the instrument checks for missing sensors. In the case of a missing sensor, the instrument displays the Sensor Missing screen and alarms until it is turned OFF. Otherwise, the turn-ON sequence continues.

The instrument displays:

- Alarm and display self test
- Manufacturer name
- Instrument name
- Software version
- Sensor discovery
- Combustible gas type
- Toxic gas units
- Alarm setpoints ( , ) ( , )
- Calibration values
- Date and time display
- Last cal date (if activated)
- CAL due date (if activated)
- Fresh Air Setup option.

Refer to flowchart in Appendix, Section 7.1.

3.2.1 Screen Displays during Startup

During the power-up sequence, all automatic page display timeouts are preset to a range from two to four seconds. Several sequences and screens occur during start up:

Instrument Self Test

The instrument performs a self test.

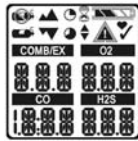

Instrument Name and Software version

Software version and instrument name display.



Combustible Gas Type

Name of Combustible Gas Type displays, e.g. BUTANE. Combustible gas type can be changed manually through the SENSOR SETUP menu or the MSA Link software.



Toxic Gas Units

Name of Toxic Gas Units displays (ppm or mg/m³). Toxic units can only be modified through the MSA Link software.



Alarm Setpoints

Alarm setpoints for all installed and activated sensors display. LOW alarm setpoints display, followed by HIGH alarm setpoints. Alarm setpoints can be changed manually through the Setup menu or the MSA Link software.



STEL and TWA Setpoints

The preset STEL and TWA values for installed and activated sensors display.



Calibration Values

The preset Calibration values for installed and activated sensors display.

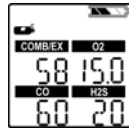

Time and Date

The date displays in a month, day and year format.

In the event that the battery is fully discharged, the time and date reset. At startup, the user is prompted to enter the time and date.

If the time and date information is missing, they are reset to [Jan-01-2008] with time stamp [00:00].



Last CAL Date and CAL Due

These display options can be set by MSA Link software. If these options are not set, these screens are not displayed.

- By default Last Cal is activated.
- By default Cal Due is deactivated



Fresh Air Setup (FAS)

The FAS screen is prompted (see Section 3.2.2)



3.2.2 Fresh Air Setup (FAS)

The Fresh Air Setup (FAS) is for automatic ZERO calibration of the instrument.

The FAS has limits. The zero of any sensor that is outside of these limits will not be adjusted by the FAS command.

If a battery charging cycle is interrupted before it is completed (4 hours for a fully discharged battery), allow the instrument's internal temperature to stabilize for 30 minutes before performing a Fresh Air Setup.

⚠ WARNING

Do not activate the Fresh Air Setup unless you are certain you are in fresh, uncontaminated air; otherwise, inaccurate readings can occur which can falsely indicate that a hazardous atmosphere is safe. If you have any doubts as to the quality of the surrounding air, do not use the Fresh Air Setup feature. Do not use the Fresh Air Setup as a substitute for daily calibration checks. The calibration check is required to verify span accuracy. Failure to follow this warning can result in serious personal injury or death.



Figure 3-1. Fresh Air Setup

If this option is enabled, the instrument displays "FAS?", prompting the user to perform a Fresh Air Setup.

1. Press the ▲ button to bypass the Fresh Air Setup.
 - The Fresh Air Setup is skipped
 - The instrument goes to the Measuring page (Main page).
2. Press the Ⓞ button within 10 seconds to perform the Fresh Air Setup.
 - The instrument starts the FAS.
 - The screen shows a No Gas Symbol, a blinking hourglass, and all enabled gas sensor readings.
 - At the end of the FAS Calibration, the instrument displays "FAS OK" or "FAS ERR". along with the flags of the sensors that were outside of the FAS limits. All sensors that are within the FAS limits will be zeroed.

3.3. Measurement Mode (Normal Operation)

In Normal Operation mode, the user can check the Minimum and Peak readings prior to clearing the STEL and TWA values or performing a Span and Zero Calibration.

The following options pages can be executed from the Normal Operation screen:

Bump Page

This page allows the user to perform a bump check.



Peak Page

This page shows the peak readings for all sensors.

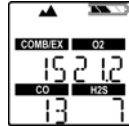

Min Page

This page shows the minimum reading for the oxygen sensor.



STEL Page

This page shows the calculated STEL readings of the instrument.

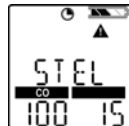

TWA Page

This page shows the calculated TWA readings of the instrument.

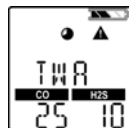

Time / Date Page

This page shows actual time and date settings of the instrument.

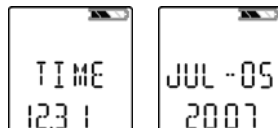

Motion Alert

This page allows the Motion Alert feature to be activated or deactivated.



Using the three instrument buttons, the user can navigate through each sub-menu in a top/down sequence.

Refer to section 2.3 and 7.3 in the appendix for detailed instructions on navigating through these screens.

3.4 Instrument Setup

This section describes the configuration options that are available through the Options Setup menus. These menus can be accessed only when the instrument is turned ON while pressing and holding the ▲ button (see Sections 3.2 and 7.3).

This mode can only be activated at instrument turn-ON.

The operation is as follows:

1. Press and hold the ▲ button while turning the instrument ON.
 - Use the ▲ and ▼ buttons to enter the setup password. The default password is "672".
2. Press Ⓟ button to enter the setup menus.
 - Incorrect password: instrument enters the Measure mode.
 - Correct password: instrument continues/beeps three times.

The password can be changed through the MSA Link software.

In the Setup mode:

- Press the Ⓟ button to store chosen value or go to the next page.
- Press ▲ button to increase values by one or toggle a selection ON or OFF.
- Press and hold ▲ button to increase values by 10.

- Press ▼ button to decrease values by one or toggle a selection ON or OFF.

Press and hold ▼ button to decrease values by 10.

The following options are available by pressing the ▼ and ▲ buttons:

- Sensor Setup (SENSOR SETUP) - see Section 3.4.1
- Calibration Setup (CAL SETUP) - see Section 3.4.2
- Alarm Setup (ALARM SETUP) - see Section 3.4.3
- Setup Time and Date (TIME SET) - see Section 3.4.4
- EXIT.

3.4.1 Sensor Setup

Each sensor can be turned ON or OFF.

For more information, see the flow charts in Section 7.6.



Figure 3-2. Sensor Setup

1. To bypass this setup, press the ▲ or ▼ button; otherwise, continue as follows.
2. Press the ⬤ button to enter the submenu.
3. Use the ▲ or ▼ button to change the option and confirm with the ⬤ button.
4. Repeat this procedure for all other sensors.
5. After setting the last sensor, continue to Calibration Setup.

3.4.2 Calibration Setup

The user can change and set the calibration values for each sensor. It is also possible to select whether the Cal Due screen is displayed and set the number of days until the next calibration is due. For more information, see the flow charts in Section 7.7.



Figure 3-3. Calibration Setup

1. To bypass this setup, press the ▲ or ▼ button; otherwise, continue as follows.
2. Press the Ⓟ button to enter the submenu.
 - The calibration gas concentration of the first sensor is shown.
3. Press the ▲ or ▼ button to change the value.
4. Press the Ⓟ button to store the value.
 - Setup screen for the next sensor is displayed.
5. Repeat the procedure for all other sensors.
 - After setting the last sensor, the user is prompted to set CALDUE.
6. Press the ▲ or ▼ button to enable or disable CALDUE Press the Ⓟ button to confirm the selection.
7. If CALDUE is set ON, press the ▲ or ▼ button to select the number of days
8. Confirm with the Ⓟ button.
9. After confirmation, continue to Alarm setup.

3.4.3 Alarm Setup

The user can switch all alarms ON or OFF and change the alarm setpoints for each sensor. For more information, see the Section 7.8 flow charts. See section 5.2 for alarm adjustment limits. The value of the High Alarm can only be set to a value higher than the Low Alarm setpoint.



Figure 3-4. Alarm Setup

1. To bypass this setup, press the ▼ or ▲; otherwise, continue as follows.
 2. Press the Ⓟ button to enter the submenu.
 3. Set alarms ON or OFF by pressing the ▲ or ▼ button. Confirm with the Ⓟ button.
 - LOW ALARM settings for the first sensor display
 4. Press the ▲ or ▼ button to change the value.
 5. Press the Ⓟ button to store the value.
 - HIGH ALARM settings for the first sensor display.
 6. Press the ▲ or ▼ button to change the value.
 7. Press the Ⓟ button to store the value.
 - STEL ALARM settings (for toxic sensors only) display.
 8. Press the ▲ or ▼ button to change the value.
 9. Press the Ⓟ button to store the value.
 - TWA ALARM settings (for toxic sensor only) for display.
 10. Press the ▲ or ▼ button to change the value.
 11. Press the Ⓟ button to store the value.
 12. Repeat the procedure for all other sensors.
 13. After setting the last sensor, continue to Time and Date setup.
- 60% LEL or 3.0% volume of methane is the maximum High Alarm setpoint that can be programmed by the user.

The alarms can be silenced momentarily by pressing the ▲ button. However, if the gas concentration causing the alarm is still present, the unit will go back into alarm.

3.4.4 Setup Time and Date

This submenu is for setting date and time. For more information see the flow charts in Section 7.9.



Figure 3-5. Date and Time Setup

1. To bypass this setup, press the ▼ or ▲ button; otherwise, continue as follows.
2. Press the Ⓟ button to enter the submenu.
3. Set month by pressing the ▲ or ▼ button.
4. Press the Ⓟ button to confirm month.
5. Repeat this procedure for day, year, hours and minutes.
 - By default, time displays in a 12-hour format.
 - The EXIT screen displays next.
6. Confirming this screen with the Ⓟ button exits the instrument setup.
 - If the sensors have not warmed up yet, the countdown displays.
 - The instrument then goes to Measuring mode.

3.5 Data Logging

Connecting Instrument to PC

1. Switch ON the ALTAIR 4X and align the Datalink Communication port on the ALTAIR 4X to the IR interface of the PC.
2. Use the MSA Link software to communicate with the instrument. See MSA Link documentation for detailed instructions.

3.6 Function Tests on the Instrument

Alarm Test

Turn ON the instrument. Verify that:

- all LCD segments are activated momentarily
- alarm LEDs flash
- horn sounds briefly
- vibrating alarm triggers briefly.

3.7 Safe LED

The instrument is equipped with a green "SAFE LED". This green SAFE LED flashes every 15 seconds under the following conditions:

- the SAFE LED feature is enabled
- instrument is in Measurement mode (Normal Operation)
- combustible reading is 0% LEL or 0.00% CH₄
- Oxygen (O₂) reading is 20.8%
- Carbon Monoxide (CO) reading is 0 ppm or 0 mg/m³
- Nitrogen Dioxide (NO₂) reading is 0 ppm or 0 mg/m³
- Hydrogen Sulfide (H₂S) reading is 0 ppm or 0 mg/m³
- no gas alarms are present (low or high)
- instrument is not in Low Battery warning or alarm
- CO, H₂S, STEL and TWA readings are 0 ppm or 0 mg/m³.

3.8 Calibration Check

⚠ WARNING

Perform a Calibration Check before each day's use to verify proper instrument operation. Failure to perform this test can result in serious personal injury or death.

This test quickly confirms that the gas sensors are functioning. Perform a full calibration periodically to ensure accuracy and immediately if the instrument fails the Calibration Check. The Calibration Check can be performed using the procedure below or automatically using the GALAXY GX2 Test Stand.

3.8.1 Equipment.

See accessory section for ordering information for these components.

- Calibration Check Gas Cylinder
- 0.25 liters/min. Flow Regulator
- 1/8" ID Superthane Ester Tubing
- ALTAIR 4X Calibration Cap.

3.8.2 Performing a Calibration Check

The calibration check is simple and should only take about one minute.

Perform this calibration check before each day's use.

1. Turn ON the ALTAIR 4X Detector in clean, fresh air.
2. Verify that readings indicate no gas is present.
3. Attach calibration cap to the ALTAIR 4X Multigas Detector.
 - Insert tab on calibration icap into slot on instrument.
 - Press calibration cap as shown until it seats onto instrument.

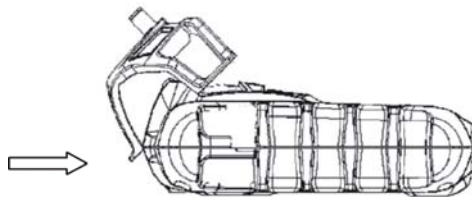

- Press both side tabs down onto instrument until they snap in.



4. Attach regulator (supplied with calibration kit) to the cylinder.
5. Connect tubing (supplied with calibration kit) to the regulator.
6. Attach other end of tubing to the calibration cap.
7. Open the valve on the regulator.
 - The regulator flow rate is 0.25 lpm.
 - The reading on the ALTAIR 4X Multigas Detector display should be within the limits stated on the calibration cylinder or limits determined by your company.
 - If necessary, change cylinder to introduce other calibration gases.
 - If readings are not within these limits, the ALTAIR 4X Multigas Detector requires recalibration. See Section 3.9, "Calibration."

3.9 Calibration

- For 30 C.F.R. Part 75 determinations (MSHA versions), the ALTAIR 4X Multigas Detector must be operated in the 0-5% by volume CH₄ mode and must be calibrated with 2.5% by volume methane.

The ALTAIR 4X can be calibrated manually using this procedure or automatically using the Galaxy or GALAXY GX2 Test Stand. Refer to 7.7 of the Appendix. Calibration must be performed using a flow regulator with a flow rate set to 0.25 liters per minute.

If a battery charging cycle is interrupted before it is completed (4 hours for a fully discharged battery), allow the instrument's internal temperature to stabilize for 30 minutes before performing a Calibration.

3.9.1 Fresh Air Setup and Zero Calibration

To skip the ZERO procedure and move directly to the calibration span procedure, push the ▲ button. If no button is pushed for 30 seconds, the instrument prompts user to perform a SPAN calibration before returning to the Normal Operation mode.

1. Press and hold the ▲ button in Normal Operation mode for three seconds.
2. If calibration lockout option is selected, enter password.

If calibration lockout option is NOT selected:

- ZERO screen displays.

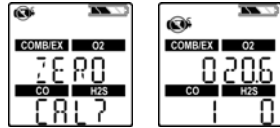

3. With the instrument exposed to fresh air, press the \odot button to confirm the ZERO screen. A sensor Refresh and Zero Calibration now occur.

NOTE: Alternatively, press the \blacktriangledown button to execute a Fresh Air setup (FAS). See section 3.2.2 for more details.

- After ZERO calibration completes, the instrument momentarily displays “ZERO PASS” or “ZERO ERR” along with the flag of any sensor that failed.



NOTE: During instrument zero calibration, the oxygen sensor is also span calibrated to 20.8% oxygen fresh air, adjusting the calibration curve as needed. During instrument span calibration, the O₂ sensor's accuracy is checked against a known oxygen gas concentration without adjusting the calibration curve.

3.9.2 Span Calibration

To skip the Span procedure, push the \blacktriangle button.

If no button is pushed for 30 seconds, the instrument returns to the Measuring mode.

1. Once the zero is set, the span screen displays.
2. Connect the appropriate calibration gas to the instrument.

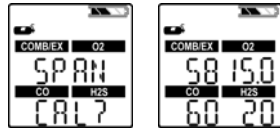

3. Attach the calibration cap to the instrument.
 - Insert tab on calibration cap into slot on instrument.
 - Press calibration cap as shown until it seats onto instrument.

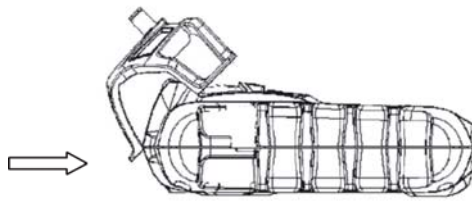

- Press both side tabs down onto instrument until they snap in.

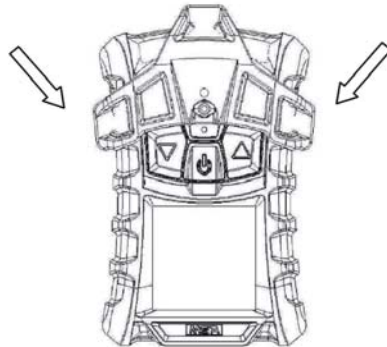

- Ensure that the calibration cap is properly seated.
 - Connect one end of the tubing to the calibration cap.
 - Connect other end of tubing to the cylinder regulator (supplied in the calibration kit).
- 4. Open the valve on the regulator.
- 5. Press the ϕ button to calibrate (span) the instrument.
 - LEDs flash
 - SPAN calibration starts.

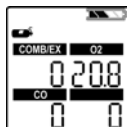

After the SPAN calibration completes, the instrument momentarily displays "SPAN PASS" successfully.

If a sensor is nearing its end of life, this "SPAN PASS" indication is followed by the end of sensor life warning (♥). The ♥ icon, and gas type of the sensor nearing end of life, blink for 15 seconds when the instrument returns to Measure mode. When in Measure mode, the heart icon is continuously displayed.

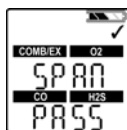

If the span calibration is unsuccessful:

- a Sensor Life Indicator displays (▲ and ♥) to show the sensor has reached its end of life and should be replaced
- The unit remains in alarm state until the ▲ button is pressed
- The ▲ and ♥ symbols remain on the display until a successful calibration or the sensor in question is replaced.

NOTE: A span calibration can fail for many reasons other than a sensor at the end of its life. If a span calibration failure occurs, verify items such as remaining gas in the calibration cylinder, gas expiration date, security of the calibration cap, etc. and repeat calibration prior to replacing the sensor.

3.9.3 Finishing Calibration

1. Close the valve on the regulator.
2. Remove the calibration cap.

The calibration procedure adjusts the span value for any sensor that passes the calibration test; sensors that fail calibration are left unchanged. Since residual gas may be present, the instrument may briefly go into an exposure alarm after the calibration sequence is completed.

4. Maintenance





If an error occurs during operation, use the displayed error codes to determine appropriate next steps.

WARNING

Repair or alteration of the ALTAIR 4X Multigas Detector, beyond the procedures described in this manual or by anyone other than a person authorized by MSA, could cause the instrument to fail to perform properly. Use only genuine MSA replacement parts when performing any maintenance procedures described in this manual. Substitution of components can seriously impair instrument performance, alter intrinsic safety characteristics or void agency approvals.

FAILURE TO FOLLOW THIS WARNING CAN RESULT IN SERIOUS PERSONAL INJURY OR DEATH.

4.1 Troubleshooting

PROBLEM	DESCRIPTION	REACTION
ERROR TEMP	Temperature is below -40°F (-40°C) or above 167°F (75°C)	Return to normal temperature range and recalibrate. Contact MSA
ERROR EE	EEPROM Memory error	Contact MSA
ERROR PRG	Flash Memory error	Contact MSA
ERROR RAM	RAM Memory error	Contact MSA
ERROR UNK	Unknown error	Contact MSA
 LOW BATTERY	Battery warning repeats every 60 seconds	Remove from service as soon as possible and recharge battery
 BATTERY ALARM	Battery is completely discharged	Instrument is no longer sensing gas. Remove from service and recharge battery
ERROR CHARGE	Charge error	Instrument must be between 10 and 35°C to charge. Contact MSA if problem persists
SENSOR ERROR	Missing Sensor	Verify sensor is properly installed and recalibrate. Contact MSA if problem persists
Instrument does not turn ON	Low battery	Charge instrument
	Sensor warning	Sensor is near its end of life
 & 	Sensor alarm	Sensor has reached end of life and cannot be calibrated. Replace sensor and recalibrate

4.2 Live Maintenance Procedure - Replacing and Adding a Sensor

⚠ WARNING

Do not open the instrument in a hazardous area. Failure to follow this warning can result in serious personal injury or death.

⚠ CAUTION

Before handling the PC board, the user must be properly grounded; otherwise, static charges could damage the electronics. Such damage is not covered by the warranty. Grounding straps and kits are available from electronics suppliers.

⚠ WARNING

Remove and reinstall sensors carefully, ensuring that the components are not damaged; otherwise instrument intrinsic safety may be adversely affected, wrong readings could occur, and persons relying on this product for their safety could sustain serious personal injury or death.

To add a sensor to an instrument that is not already equipped with a full array of sensors, remove the sensor plug from in front of the formerly unused sensor housing.

⚠ CAUTION

While instrument case is open, do not touch any internal components with metallic/conductive objects or tools. Damage to the instrument can occur.

1. Verify that the instrument is turned OFF.
2. Remove the four case screws, and remove the case front while carefully noting the orientation of the sensor gasket.
3. Gently lift out and properly discard the sensor to be replaced.
 - Using fingers only, gently remove the toxic, combustible, or oxygen sensor by gently rocking it while pulling it straight from its socket.
4. Carefully align the new sensor contact pins with the sockets on the printed circuit board and pressing it firmly in place.

NOTE: Ensure tab on sensor aligns with groove at top of holder.

- Insert the toxic sensor by placing it in the left-hand position of the sensor holder.
 - Insert the O₂ sensor by placing it in the right-hand position of the sensor holder.
 - Insert the combustible sensor by placing it in the middle position of the sensor holder.
 - If any sensor is not to be installed, ensure that a sensor plug is installed properly in its place.
5. Reinstall the case front.
 6. Re-install the screws.
 7. Power ON the instrument. The instrument automatically senses that a new sensor is installed and displays the "SENSOR DSCVRY" screen. If the sensor replaced is the same as the previous sensor, the instrument starts up normally. Proceed to step 10 and calibrate the instrument.
 8. If the sensor installed is not the same as the previous configuration, the instrument automatically senses the difference when it is turned ON via "SENSOR CHANGE" on the display and prompts the user to accept or reject the change. "ACCEPT?" appears on the display. The left ▼ button accepts or the right ▲ button rejects the change. Go into the sensor setup and turn ON the appropriate sensor after being prompted for a password. Refer to sensor setup section 3.4.1 for more details.
 9. Calibrate the instrument after the sensors have stabilized.

Allow sensors to stabilize at least 30 minutes before calibration.

⚠ WARNING

Calibration is required after a sensor is installed; otherwise, the instrument will not perform as expected and persons relying on this product for their safety could sustain serious personal injury or death.

4.3 Cleaning the Instrument

Clean the exterior of the instrument regularly using only a damp cloth. Do not use cleaning agents as many contain silicones which damage the combustible sensor.

4.4 Storage

When not in use, store the instrument in a safe, dry place between 65°F and 86°F (18°C and 30°C). After storage, always recheck instrument calibration before use.

4.5 Shipment

Pack the instrument in its original shipping container with suitable padding. If the original container is unavailable, an equivalent container may be substituted.

5. Technical Specifications/Certifications

5.1 Technical Specifications

WEIGHT	8.3 oz. (instrument with battery and clip)				
DIMENSIONS (L x W x H)	4.4 x 3.00 x 1.37 inches – without fastening clip				
ALARMS	Four gas alarm LEDs, a charge status LED, an audible alarm, and a vibrating alarm				
VOLUME OF AUDIBLE ALARM	95 dB typical				
DISPLAY	LCD display				
BATTERY TYPE	Rechargeable Li ION battery. Li ION battery must not be charged in Ex area				
INSTRUMENT RUN TIME	34 hours at 77°F (25°C)				
CHARGING TIME	≤ 4 hours The maximum safe area charging voltage Um = 6.7 Volts D.C				
TEMP RANGE	14 to 104°F	(-10 to 40°C)	Normal operating range		
	-4 to 122°F	(-20 to 50°C)	Extended operating range		
	50 to 95°F	(10 to 35°C)	While charging battery)		
HUMIDITY RANGE	15 - 90% relative humidity, non-condensing; 5 - 95% RH intermittent				
ATMOSPHERIC PRESSURE RANGE	800 to 1200 mbar				
INGRESS PROTECTION	IP 67				
MEASURING METHODS	Combustible gas: Catalytic sensor O₂ and Toxic gas: Electrochemical sensor				
MEASURING RANGE	Combustible 0-100% LEL 0-5.00% CH ₄	O₂ 0-30% Vol.	CO 0-1999 ppm	H₂S 0-200 ppm	NO₂ 0-50.0 ppm

5.2 Factory-set Alarm Thresholds and Setpoints

Sensor	LOW alarm	HIGH alarm	STEL	TWA	Min alarm setpoint	Max alarm setpoint	Auto-cal values
CH ₄	0.5% CH ₄	1% CH ₄	--	--	0.1% CH ₄	3% CH ₄	2.5% CH ₄
O ₂	19.5%	23.0%	--	--	5	29	15.0%
CO	25 ppm	100 ppm	100	25	15	1700	60 ppm
H ₂ S	10 ppm	15 ppm	15	10	5	175	20 ppm
NO ₂	2.5 ppm	5.0 ppm	5.0 ppm	2.5 ppm	1 ppm	47.5 ppm	10 ppm

Per 30CFR Part 75.320, this unit has been MSHA performance tested to 19.5% O₂

5.3 Certifications

See instrument label for the approvals that apply to your specific unit.

USA (Mining)

MSHA 30 CFR Part 22, Methane Detector.

Approved for 30 CFR Part 75 Determination testing for methane and oxygen deficiency

Performance Specification

5.4.1 Combustible Gas

Range	0 to 5% CH ₄
Resolution	0.05% vol CH ₄
Reproducibility	±0.10 %CH ₄ , 0.00% CH ₄
	±0.15 %CH ₄ , 0.25% CH ₄
	±0.15 %CH ₄ , 0.50% CH ₄
	±0.20 %CH ₄ , 1.00% CH ₄
	±0.20 %CH ₄ , 2.00% CH ₄
	±0.30 %CH ₄ , 3.00% CH ₄
	±0.30 %CH ₄ , 4.00% CH ₄
	±0.30 %CH ₄ , 4.50% CH ₄
Response Time (Typical)	90% of final reading <10 seconds (methane) (normal temperature range)

5.4.2 Oxygen

The oxygen sensor has built-in temperature compensation. However, if temperature shifts dramatically, the oxygen sensor reading may shift. Zero the instrument at the work place temperature for the least effect.

Range	0 to 30 vol.% O ₂
Resolution	0.1 vol.% O ₂
Reproducibility	0.7 vol.% O ₂ for 0 to 30 vol.% O ₂ 0.7% O ₂ for O ₂ < = 15% (MSHA version only) 0.5% O ₂ , for O ₂ : 15%<O ₂ < =30% (MSHA version only)
Response Time (Typical)	90% of final reading <10 seconds (normal temperature range)
Oxygen Sensor Cross-Sensitivity	The oxygen sensor has no common cross-sensitivities

5.4.3 Carbon Monoxide

Range	0 - 1999 ppm CO
Resolution	1 ppm CO for 6 - 1999 ppm H ₂ S
Reproducibility	± 5 ppm CO or 10 % of reading, whichever is greater (normal temperature range) ±10 ppm CO or 20 % of reading, whichever is greater (extended temperature range)
Response Time (Typical)	90% of final reading <15 seconds (normal temperature range)

TEST GAS APPLIED	CONCENTRATION (PPM) APPLIED	CO CHANNEL % CROSS-SENSITIVITY
Hydrogen Sulfide (H ₂ S)	40	0
Carbon Monoxide (CO)	100	100
Nitric Oxide (NO)	50	84
Nitrogen Dioxide (NO ₂)	11	0
Sulfur Dioxide (SO ₂)	9	-4
Chlorine (Cl ₂)	10	0
Hydrogen Cyanide (HCN)	30	-5
Ammonia (NH ₃)	25	0
Toluene	53	0
isopropanol	100	-8
Hydrogen (H ₂)	100	48

5.4.4 Hydrogen Sulfide

Range	0 - 200 ppm H ₂ S
Resolution	1 ppm H ₂ S for 3 - 200 ppm H ₂ S
Reproducibility	±2 ppm H ₂ S or 10 % of reading, whichever is greater (normal temperature range)
	±5 ppm H ₂ S or 10 % of reading, whichever is greater (extended temperature range)
Response Time (Typical)	90% of final reading <15 seconds (normal temperature range)

TEST GAS APPLIED	CONCENTRATION (PPM) APPLIED	CO CHANNEL % CROSS-SENSITIVITY
Hydrogen Sulfide (H ₂ S)	40	100
Carbon Monoxide (CO)	100	1
Nitric Oxide (NO)	50	25
Nitrogen Dioxide (NO ₂)	11	-1
Sulfur Dioxide (SO ₂)	9	14
Chlorine (Cl ₂)	10	-14
Hydrogen Cyanide (HCN)	30	-3
Ammonia (NH ₃)	25	-1
Toluene	53	0
isopropanol	100	-3
Hydrogen (H ₂)	100	0

5.4.5 Nitrogen Dioxide

Range	0 - 50.0 ppm NO ₂
Resolution	0 - 0.1 ppm NO ₂
Reproducibility	±1 ppm NO ₂ or 10% of reading, whichever is greater (normal temperature range)
	±2 ppm NO ₂ or 20% of reading, whichever is greater (extended temperature range)
Response Time (Typical)	90% of final reading 20 seconds (normal temperature range)

5.5 XCell Sensor Patents

- | | |
|--|----------------|
| 1. Combustible (P/N 10106722): | Patent Pending |
| 2. Oxygen (P/N 10106729): | Patent Pending |
| 3. Carbon Monoxide/Hydrogen Sulfide
(P/N 10106725): | Patent Pending |

6. Order Information

DESCRIPTION	PART NO.
Stainless Steel Suspender Clip	10069894
34L Quad Gas Mix (2.5% CH ₄ , 15% O ₂ , 60 ppm CO)	10049056
34L Quad Gas Mix (2.5% CH ₄ , 15% O ₂ , 60 ppm CO, 10 ppm NO ₂)	10058172
58L Quad Gas Mix (2.5% CH ₄ , 15% O ₂ , 60 ppm CO, 10 ppm NO ₂)	10058171
Calibration Assembly (cap, tube, connector)	10089321
North American Power Supply with Charge Connector	10087913
Charging Cradle Assembly with Power Supply (North America)	10087368
Vehicle Charging Cradle Assembly	10095774
MSA Link Software CD- Rom	10088099
JetEye IR Adapter with USB Connector	10082834
Combustible Sensor Replacement Kit	10121212
O ₂ Sensor Replacement Kit	10106729
CO/H ₂ S Two Toxic Sensor Replacement Kit	10106725
CO/NO ₂ Two Toxic Sensor Replacement Kit	10121217
Front Housing with Integrated Dust Filters (charcoal)	10110030
Front Housing with Integrated Dust Filters (Phosphorescent)	10110029
Main Board w/ Battery Pack	10124956
LCD Frame Assembly (frame, LCD, zebra strips, screws)	10110061
Sensors Gasket, Screws (4x), self tapping (2x)	10110062
CD Manual ALTAIR 4X	10106623

7. Appendix – Flow Charts

7.1. Start Up Sequence (Power ON)

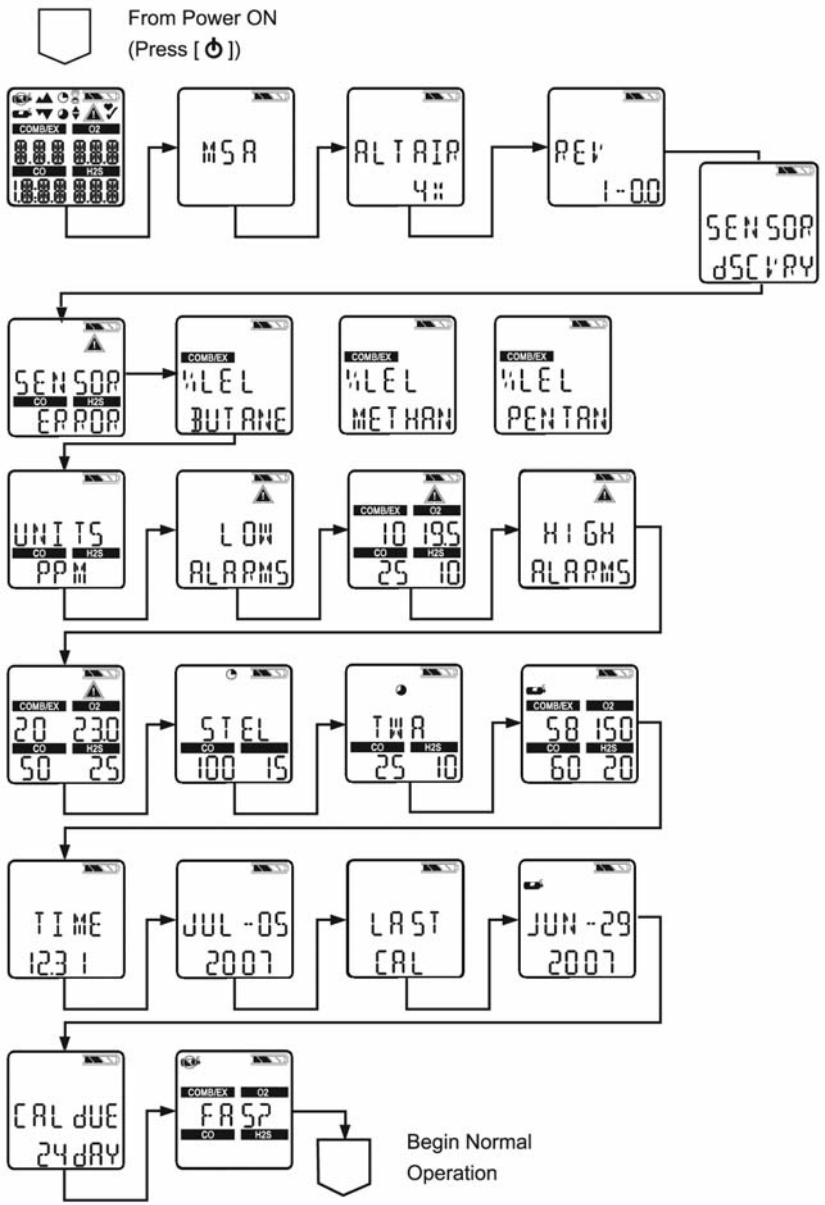

7.2 Fresh Air Setup

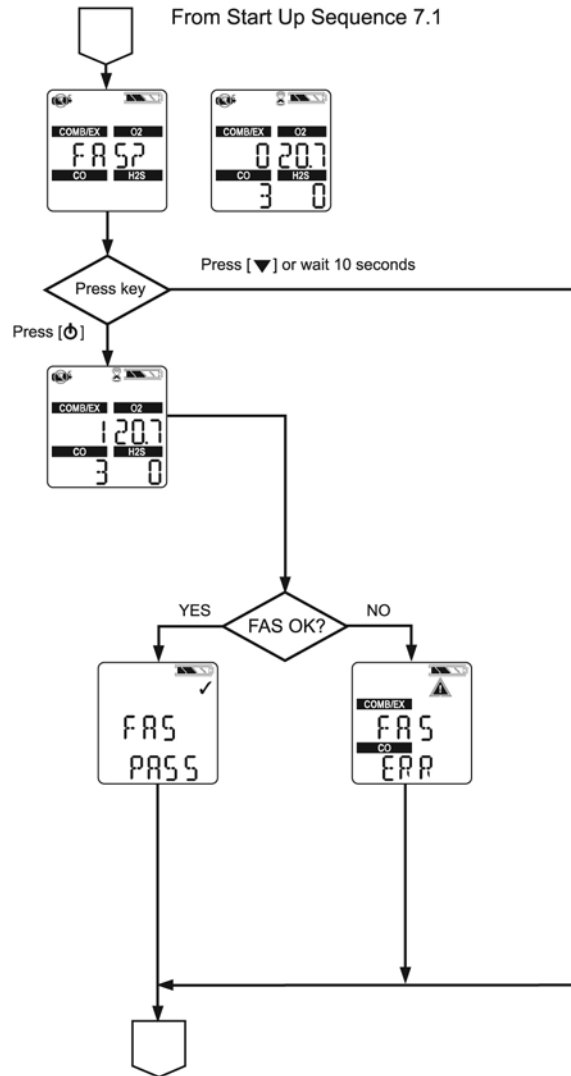

7.3 Reset Screen Controls

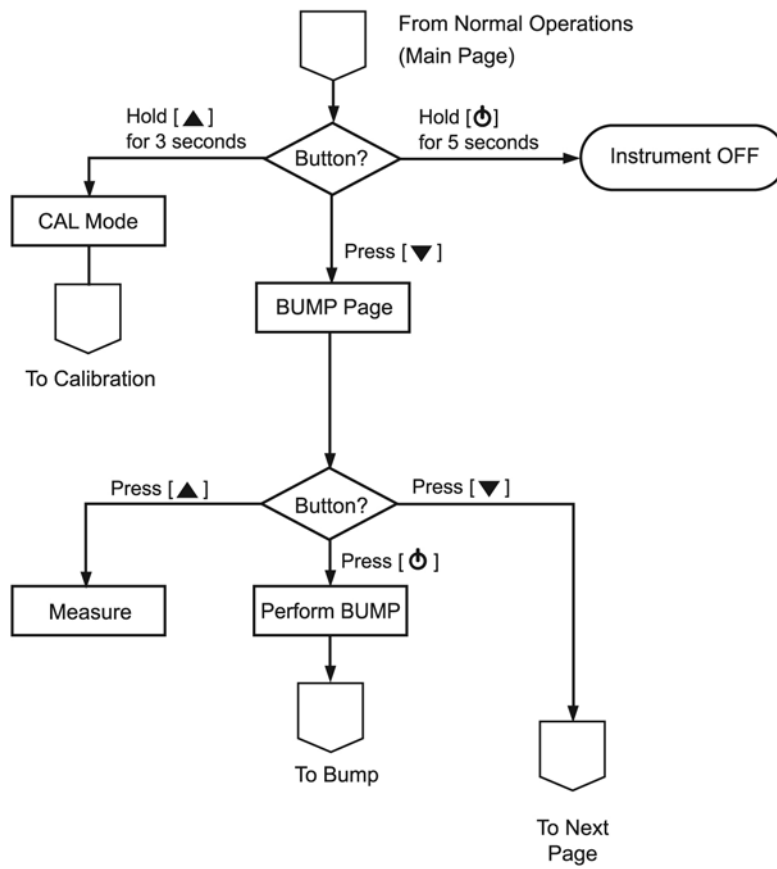

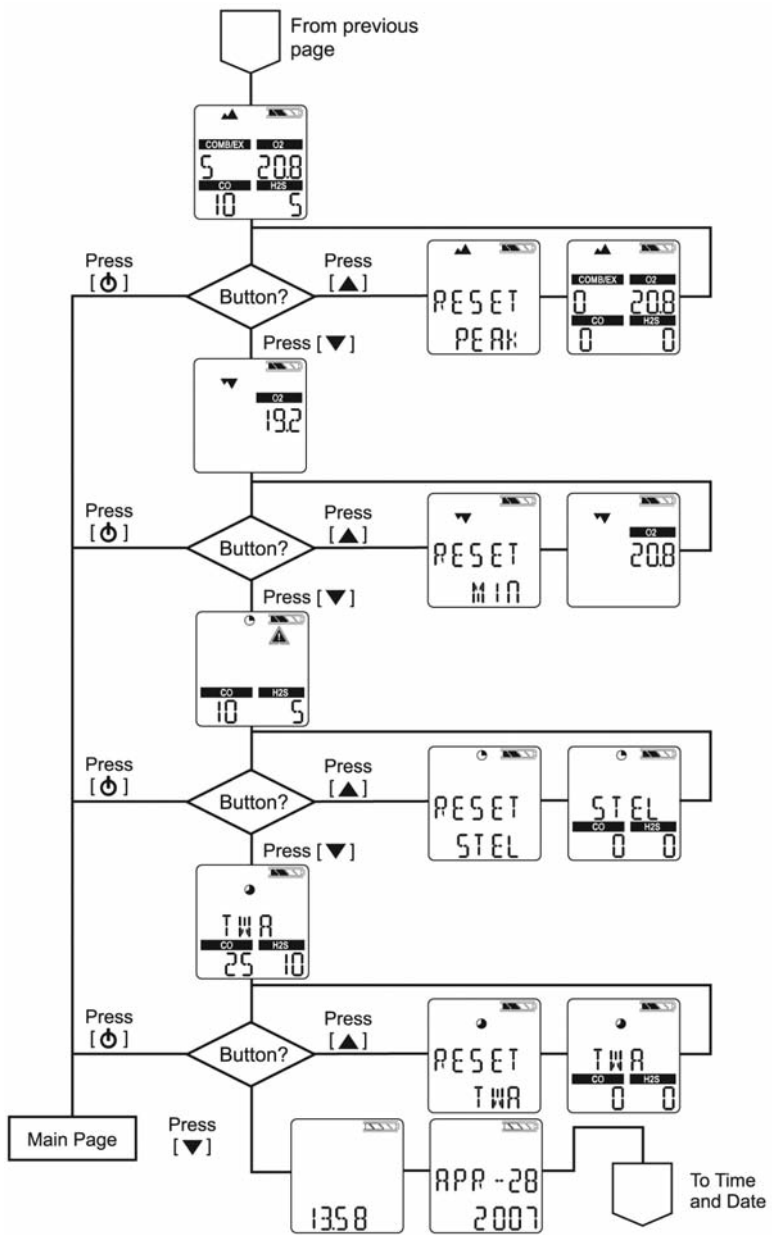

7.4 Calibrations

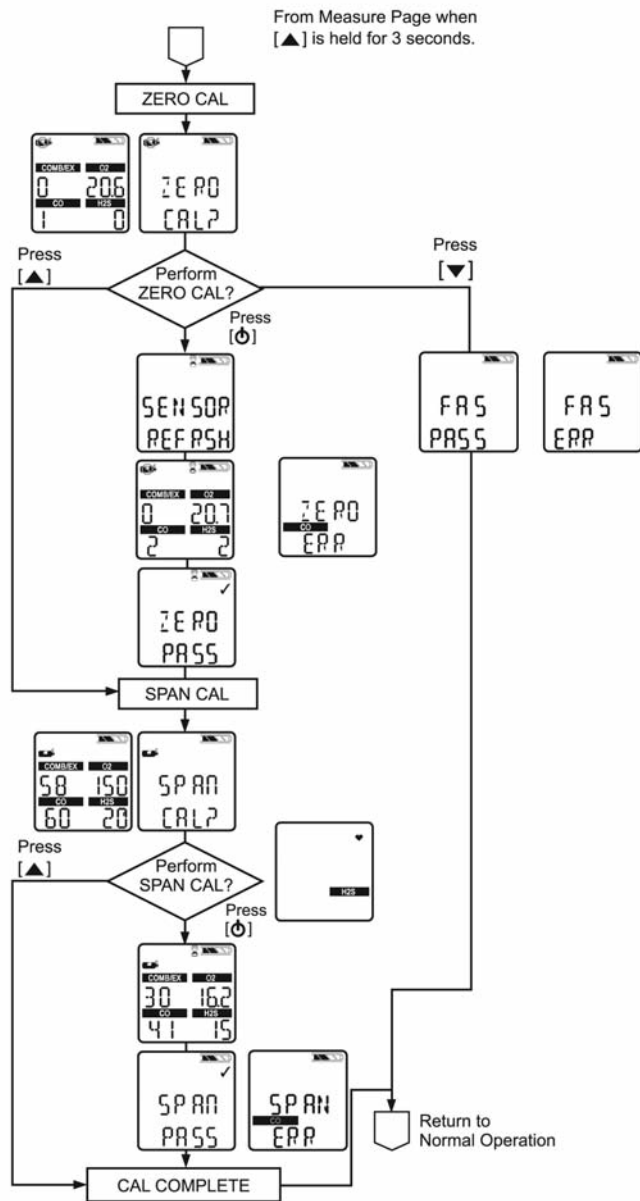

7.5 Options Setup

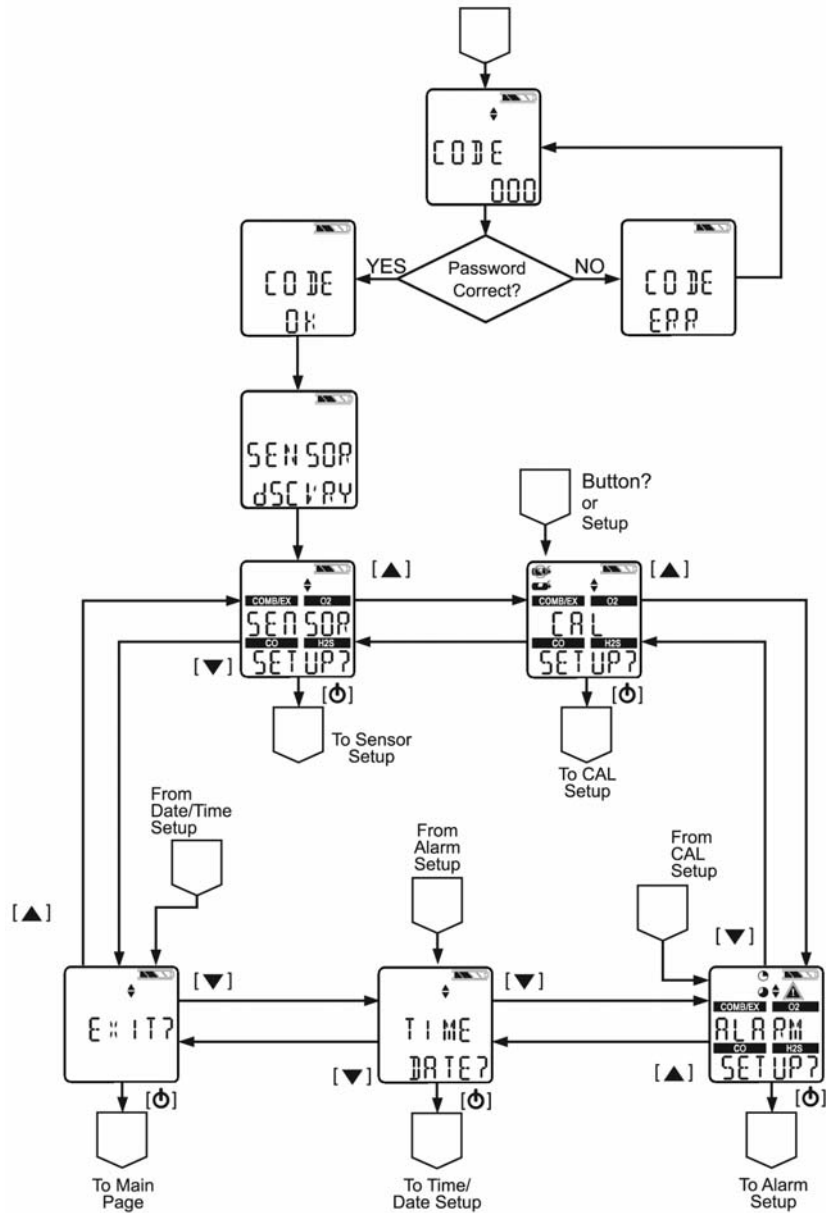

7.6 Sensor Setup

Set Sensor with [▼] or [▲].
Confirm Sensor with [⏻].

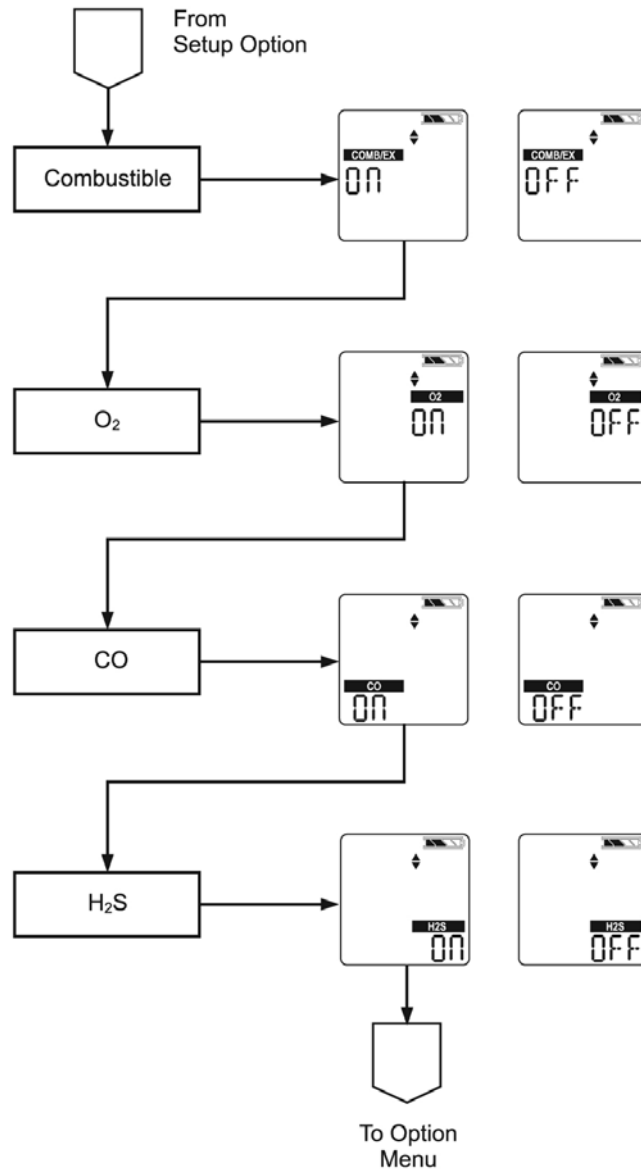

7.7 Alarm Setup

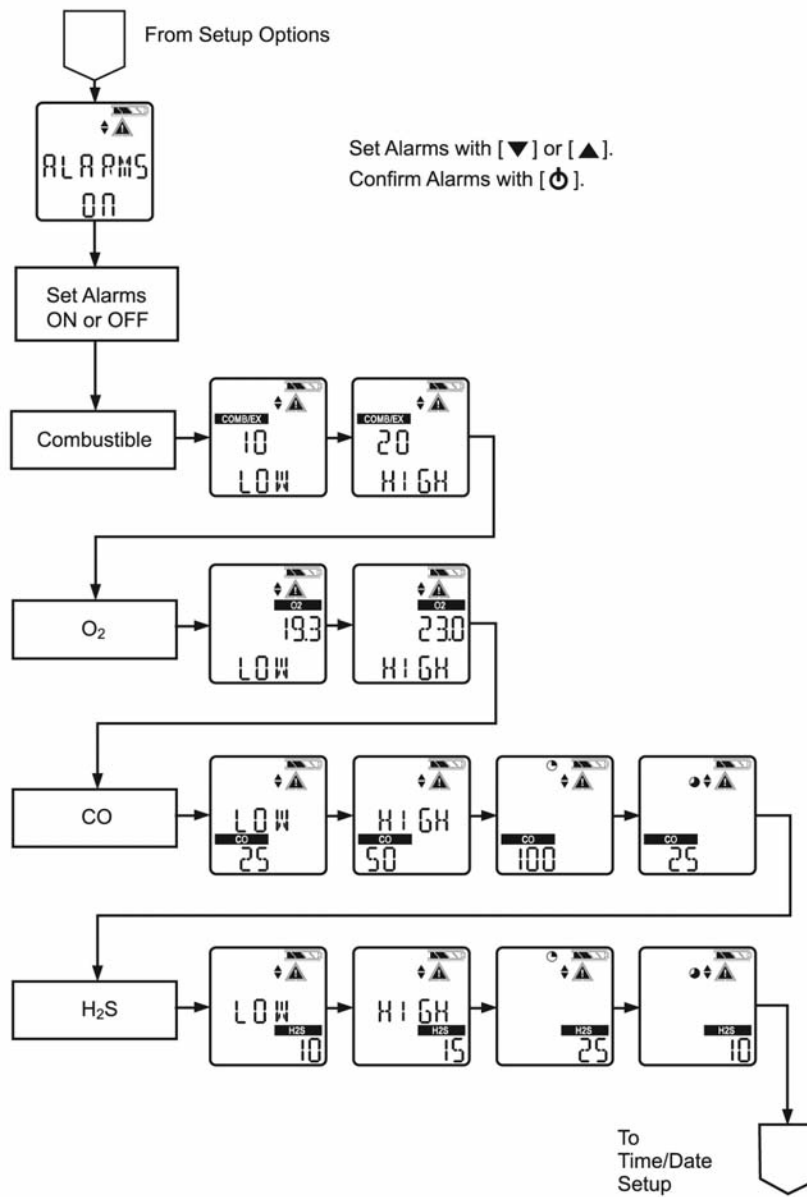

7.8 Time and Date Setup

