

# HASEGAWA ELECTRIC CO., LTD.

■ Head office/Sales division

5-8-17 Shioe, Amagasaki-city, Hyogo 661-0976  
Tel.+81-6-6429-6144 Fax.+81-6-6429-0016

■ Tokyo Branch

Nikko-Ozu Bldg. 3-9-4 Nihonbashi-Honcho, Chuo-ku, Tokyo 103-0023  
Tel.+81-3-3662-2715 Fax.+81-3-3662-2716

■ Nagoya sales office

NT Bldg. 2-15-8 Nakata, Chigusa-ku, Nagoya 464-0074  
Tel.+81-52-386-8318 Fax.+81-52-386-8317

■ Sendai sales office

Ohku-Sendai Bldg. 2-5-1 Honcho, Aoba-ku, Sendai 980-0014  
Tel.+81-22-265-9378 Fax.+81-22-713-6392

■ URL : <https://www.hasegawa-elec.co.jp>

■ E-mail: [infor@hasegawa-elec.co.jp](mailto:infor@hasegawa-elec.co.jp)

CATALOGUE-H01-0005-5 '23.5.2000D

Note: Specifications and prices are subject to change for improvement without prior notices.

All rights reserved.

(C) 2023 HASEGAWA Electric Co.,Ltd. All rights reserved.

H  
A  
S  
E  
G  
A  
W  
A  
E  
L  
E  
C  
T  
R  
I  
C  
C  
O  
.,  
L  
T  
D.

## GENERAL CATALOGUE Vol.3-3

**Voltage detector**

**Auxiliary device for voltage detection**

**Voltage detector checker**

**Phase tester**

**Grounding hook**

**Discharge stick**

**Discone hook stick**

**Illuminator**

**Measuring instrument**

**Railway products**

HASEGAWA ELECTRIC CO., LTD.

<https://www.hasegawa-elec.co.jp>



# A NEW CHALLENGE AS PIONEER

## Rising to New Challenges as a Pioneer

HASEGAWA ground-fault relays, voltage detectors, phase testers, and measuring instruments are essential to protect the safety of human lives and our society.

In this age of electronics, one that continues to progress in complexity, the importance of these products are increasing at an alarming rate.

From extra-high voltage to low-voltage products and AC to DC products used in a variety of scenes from power companies, railway companies, and FA factories for manufacturing companies to various households, our company's products play a key role in creating safe electrical environments.

We contribute to “safe electricity” by providing high-level technical skills and wholehearted devotion.

We make full use of our sensing technology to make greater leaps in our development.

Since its founding in 1925, our company has strived to develop and produce products that are key to creating safe electrical environments through products such as ground-fault relays, voltage detectors, and phase testers.

As a result, we have been able to establish ourselves as the top manufacturer in the voltage detector field, and through our original research and technology in both AC and DC relays, we have developed one-of-a-kind products and have received high praise. This is simply a result of our thorough application of “worksite principles”, and it is precisely because our entire company takes a position of wholeheartedly responding to the demands of our customers under the motto of “the truth is in the worksite” that we have been able to grow as a total-solutions consulting company for “electrical safety”.

Additionally, in recent years we have been grabbing attention in the overseas market and not just in Japan. Notably, in Southeast Asia, the HASEGAWA brand is recognized as proof of safety and reliability. We take pride in being able to contribute to our

customers, which include many infrastructure-related enterprises that support people's lives, such as power, gas, sewer, railroad, and communication companies, and in the future, we would like to make full use of our sensing technology to make great leaps in our development. We at Hasegawa believe that it is our social duty to create “a society free of electrical accidents”, and it is our intention to continue this duty with untiring efforts. It is our hope that you will continue to support and guide us in our endeavors from now and into the future.



PRESIDENT

吉田洋二郎  
Yojiro Yoshida

We are in constant pursuit of technological innovation in order to create a society of comfortable and safe electronics.

Society ever marches forward, and globally, changes are occurring at such an intensely rapid rate that even the words "IT" and "digital" are becoming obsolete in the world of electronics. HASEGAWA is able to respond to the changes of these times while continuing to be the top manufacturer of voltage detectors and relay-related products now and into the future.

To achieve this, we are resolved to never feel satisfied with our current knowledge and technology, and we are engaged in research and development with the aim of creating technology for the next generation and beyond.

The first step of creating ideas for the future starts from our "worksite". We begin by accurately understanding product usage and the demands of our customers. Following this, we continue to listen to our customers and implement their opinions through our processes of development and design, production, quality control, and sales...

Through this constant, cyclical workflow, HASEGAWA aims for greater heights and is working to make "a society free of electrical accidents" a reality.



At HASEGAWA, our work never stops. Through a never-ending cycle of activity, we respond to the demands of the next generation.

We walk in step with our customers and provide support through a 24-hour full-support system. We support our customers through reliable consulting.

We develop our products after giving our full attention to the opinions of our customers and thoroughly analyzing what is being demanded by the market and the times.

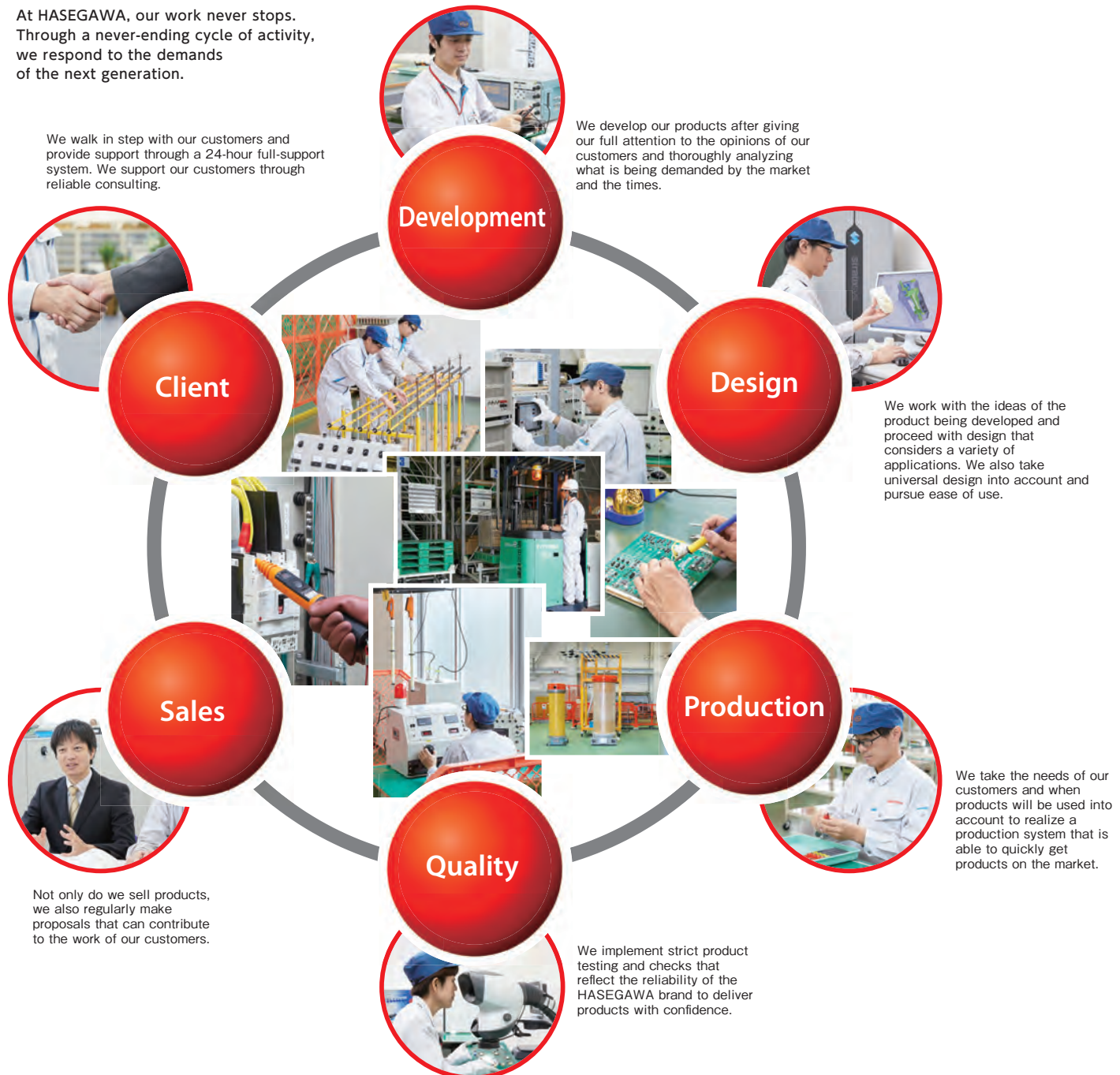

## Company Overview

**Founded:** July 1925  
**Established:** September 20, 1971  
**Capital:** 41.6 million yen  
 (authorized capital: 64 million yen)  
**Representatives:** Chairman: Osamu Yoshida  
 President: Yojiro Yoshida

### [Locations]

**Head Office:** 5-8-17, Shioe, Amagasaki-city, Hyogo 661-0976  
 TEL: +81-6-6429-6144 FAX: +81-6-6429-0016  
 JR: (071) 3710 FAX: (071) 3710  
**Tokyo Branch:** Nikko-Ozu Bldg. 3-9-4 Nihonbashi-Honcho, Chuo-ku, Tokyo 103-0023  
 TEL: +81-3-3662-2715 Fax: +81-3-3662-2716  
**Nagoya Sales Office:** NT Bldg. 2-15-8 Nakata, Chigusa-ku, Nagoya 464-0074  
 Tel: +81-52-386-8318 Fax: +81-52-386-8317  
**Sendai Sales Office:** Ohku-Sendai Bldg. 2-5-1 Honcho, Aoba-ku, Sendai 980-0014  
 Tel: +81-22-265-9378 Fax: +81-22-713-6392  
**General Testing Office:** 5-6-20, Shioe, Amagasaki-city, Hyogo 661-0976

### [Business Contents]

**Voltage detectors:** Low voltage detectors, high voltage detectors, extra-high voltage detectors, DC voltage detectors, and other auxiliary devices for voltage detection  
**Phase testers:** Low voltage phase testers, high voltage phase testers, extra-high voltage phase testers  
**Relays:** Bus relays, ground-fault directional relays, ground-fault overvoltage relays, high voltage ground-fault relays, short-circuit relays, DC ground-fault relays, etc.  
**Current transformers:** Zero-phase current transformers  
**Grounding transformers:** Low voltage grounding transformers, high voltage grounding transformers  
**Measuring instrument-related:** Leakage monitors,  $\omega C$  measuring instruments, etc.  
**Grounding tools:** Grounding hook sticks, discharge sticks  
**LED-related:** Working lights, helmet lights, etc.  
**Other:** Consulting related to ground-fault relay systems, measuring systems, etc.  
 Research, design, and production for co-development with customers

### [Major Clients]

Various power companies and related enterprises, various electrical safety associations, various electric construction firms, various companies related to Japan Railways and private railways, NTT, electronic material trading firms, etc.

### [Banks]

MUFG Bank, Amagasaki Ekimae Branch  
 Resona Bank, Dojima Branch  
 Sumitomo Mitsui Bank, Umeda Branch



## We work with our group company to aid in providing stable electrical power.

We work with our group company to contribute to the stability and safety of electrical power supply with a focus on relays, voltage detectors, and other devices that are essential for the protection and maintenance of devices related to electrical power and industrial equipment as well as solar power generation.

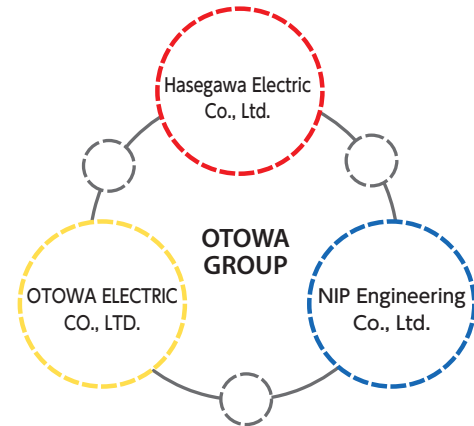

### OTOWA ELECTRIC CO., LTD.

Provides total solutions for lightning-related products, including lightning-resistant elements, the first SPDs for direct lightning hits in Japan, SPDs for power sources, and lightning-resistant transformers.

### NIP Engineering Co., Ltd.

Provides total solutions for anti-lightning measures, including the manufacture, sales, design, construction, and lightning-damage solutions consultation for lightning arrester equipment (lightning rods), as well as the maintenance of solar power generation systems

### Ceraon Co., Ltd.

Manufactures and sells ceramic devices

### Meneon Co., Ltd.

Performs electrical work as well as maintenance and management for electrical facilities

### Geological Assessment Tech Co., Ltd.

[Geological survey and water quality survey], [grounding design, grounding resistance reduction work and consulting], [planning, design, and consultation of external and internal lightning protection measures]

### Otowa Korea Co., Ltd.

Sells various lightning arrestors as well as other electronic machinery and devices.

## Our Company's Journey

### [Company History]

- 1925 Founded in Osaka as the Hasegawa Toshihiko Trading Company  
Imports and sells relays, fuses, and voltage detectors
- 1942 Moves to Higashi Yodogawa, Osaka. Begins development and  
manufacture of bus relays and other ground-fault protection  
relays as well as voltage detectors
- 1949 Reorganizes as Hasegawa Electric Co., Ltd. (Hasegawa Denki)
- 1971 Changes trade name to Hasegawa Electric Co., Ltd. (Hasegawa  
Denki Kogyo) Kametaro Yoshida becomes President and  
Representative Director
- 1975 Begins sale of the "HS-7 audible, light-emitting voltage detector"
- 1986 Osamu Yoshida becomes President and Representative Director
- 1995 Issues "The Great Hanshin Earthquake for Our Company"
- 1996 Begins sale of the "HT-610 $\alpha$  low voltage detector"
- 1997 Begins sale of the "RRG-1  $\omega$ C measurement type ground fault  
protection relay"
- 1999 The HT-600 series of low voltage detectors achieves 1 million  
units in sales
- 2001 Receives ISO 9001 certification
- 2003 Receives ISO 14001 certification
- 2008 Main factory moves to Shioe, Amagasaki City
- 2011 Issues the technical periodical "Understanding  $\omega$ C Ry"
- 2013 Establishes Sendai Sales Office
- 2014 Tatsuo Matsuoka becomes President and Representative Director
- 2015 First appearance at the Korea Expo (actively participates in  
international exhibitions after this)
- 2017 Head office and factory moves to new building
- 2018 Yojiro Yoshida becomes President and Representative Director

### [Awards Received]

- 1981 "HS Series" wins award at the Japan Electrical Construction and Materials Fair
- 1983 "HP Series" wins award at the Japan Electrical Construction and Materials Fair
- 1986 "HT-600 voltage detector" selected for the Good Design Award G Mark
- 1988 "HSS-6 voltage detector" wins award at the Japan Electrical Construction and  
Materials Fair
- 1989 "HT-610 voltage detector" selected for the Good Design Award G Mark
- 1990 "HPI-A6 phase tester" wins award at the Japan Electrical Construction and Materials Fair
- 1993 "HX-6 hot line proximity alarm" wins award at the Japan Electrical  
Construction and Materials Fair
- 1993 "HST Series voltage detector" selected for the Good Design Award G Mark
- 1994 "VG-UI2T instant ground-fault directional relay" wins award at the Japan  
Electrical Construction and Materials Fair
- 1995 "Research and development of wireless voltage detectors and phase testers"  
wins the Shibusawa Award
- 1996 "Development of  $\omega$ C measurement type ground fault protection relay  
equipment" wins Ohm Technology Award
- 1996 "HT-610 $\alpha$  voltage detector" wins Good Design Award Commissioner's Special  
Prize for Products of Small and Medium Enterprises
- 1999 "Development of lead-less voltage detectors" wins the Shibusawa Award
- 1999 "RRG-1B relay" wins award at the Japan Electrical Construction and Materials Fair
- 2000 "Lead-less phase tester" wins award at the Japan Electrical Construction and Materials Fair
- 2001 "Development of extendable voltage detectors" wins the Shibusawa Award
- 2003 "HSE-7T voltage detector for high voltage" wins award at the Japan Electrical  
Construction and Materials Fair
- 2005 "RRG-3  $\omega$ C measurement type ground fault protection relay" wins the  
Shibusawa Award
- 2007 Selected as one of the Small and Medium Enterprise Agency's "300 Small and  
Medium Enterprises Engaged in Spirited Manufacturing"
- 2007 "HT-610 $\alpha$  voltage detector" wins Good Design/Long Life Design Award
- 2010 Recognized as a leading technology enterprise in the Southern Hanshin area
- 2013 "Development of contactless AC voltage detectors" wins Railway Electrical  
Engineering Award
- 2013 "HXR contactless AC voltage detector" wins award at the Japan Electrical  
Construction and Materials Fair
- 2014 Presented with a "Certificate of Excellence in Declaration as a Corporation" by  
the Amagasaki Tax Office



Shibusawa Awards



Various awards from the Japan Electrical Construction Association



The Small and Medium Enterprise Agency's 300 Small and  
Medium Enterprises Engaged in Spirited Manufacturing



Ohm Technology Award

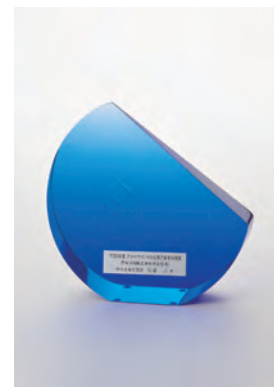

Good Design  
Commissioner's Special Prize  
for Products of Small and  
Medium Enterprises

# High voltage

- Voltage detector P.22 to 26
- Portable live part detector P.28
- Phase tester P.37 to 38
- Grounding hook P.39 to 45
- Discone hook rod P.46

## For electric substation equipment

Extra-High Voltage Detecting System (VOLTECT) P.51 to 52

Wind force power generation system

Hydroelectric power plant

high voltage substation

154kV~187kV

Primary substation

Nuclear power plant

275kV~500kV

Thermal electric power plant

# Low voltage

Voltage detector P.15 to 17  
Phase tester P.35

## For photovoltaic power generation system (DC)

Voltage detector P.17 to 18, 21

# Medium voltage

66kV~77kV

Substation for electric power distribution

6.6kV~36kV

Electricity distribution lines

6.6kV~36kV

Factories

Buildings

100~440V

Shopping street

Residences

Voltage detector P.19 to 28  
Phase tester P.35 to 38  
Hot line proximity detector P.29 to 32  
Portable live part detector P.28

Grounding hook P.39 to 45  
Discharge stick P.47 to 48  
Discone hook stick P.46

# Common

Voltage detector checker P33



Illuminator P.51



LED working light (rechargeable type) EWL-4 Ecopika-kun

## For railways (conventional railroad lines, bullet train, monorail)

Voltage detector P.53 to 57  
Grounding hook P.58

Medium voltage hot line proximity detector P.57

## For receiving plant equipment

Extra-High Voltage Detecting System (VOLTECT) P.49 to 50



# APPLICATIONS

**HST series**  
Medium voltage and high voltage detector | **P.22**

**HXA-6**  
Hot line proximity detector  
(Armband type) | **P.31**

**HTE-610W**  
Low voltage detector  
**volcheck** | **P.15**

**HPL-200**  
LV phase checker  
(Insulated wire clamping type) | **P.35**

# APPLICATIONS

**HPseries**  
Medium voltage phase tester  
Wireless type **P.38**

**HXA-6S**  
Hot line proximity detector  
(Helmet fixing type) **P.31**

**Type H**  
Grounding hook set  
Universal type for cubicle **P.44**

**HPI-A6**  
Medium voltage phase tester  
(Optical fiber type) **P.36**

**HXW-6W**  
Hot line proximity detector  
(Wrist band type) **P.30**

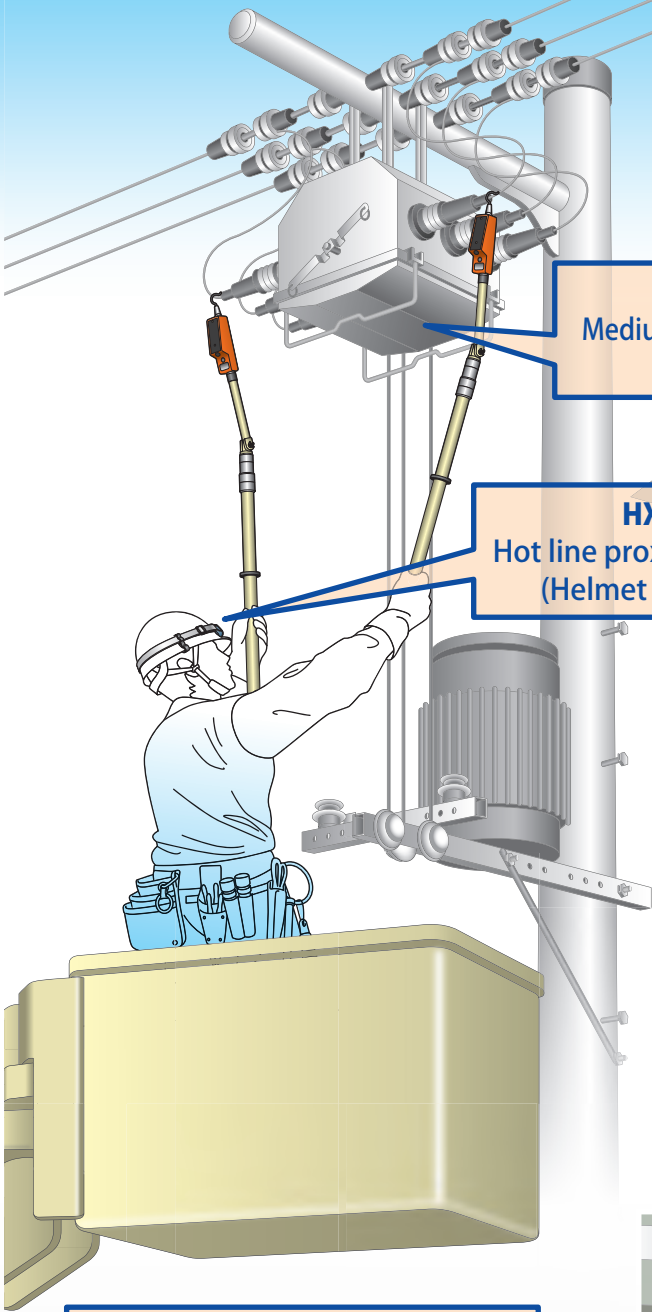
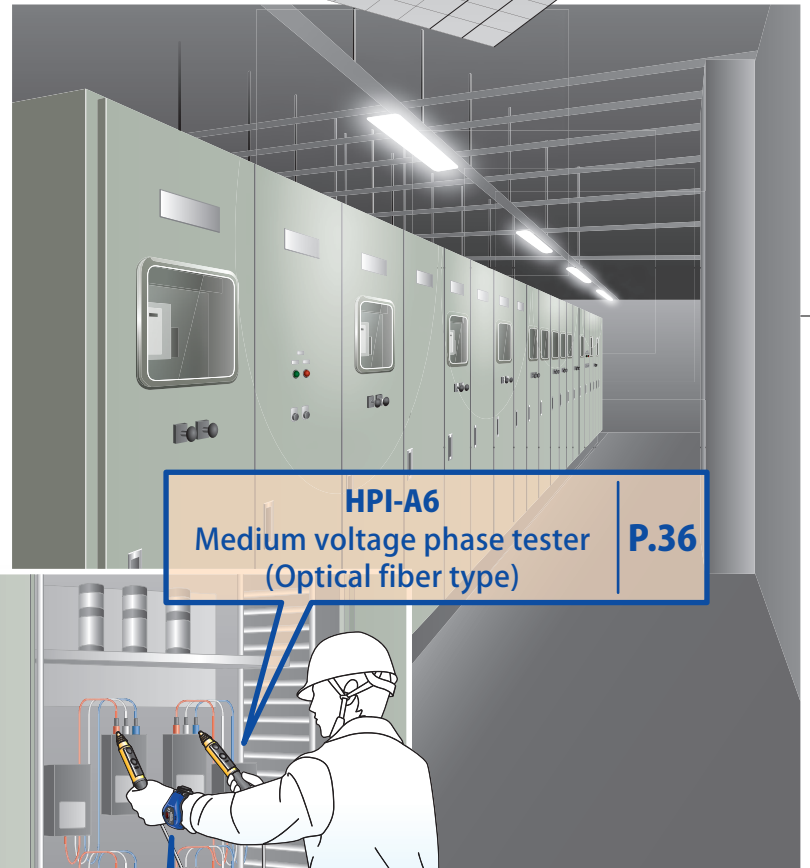
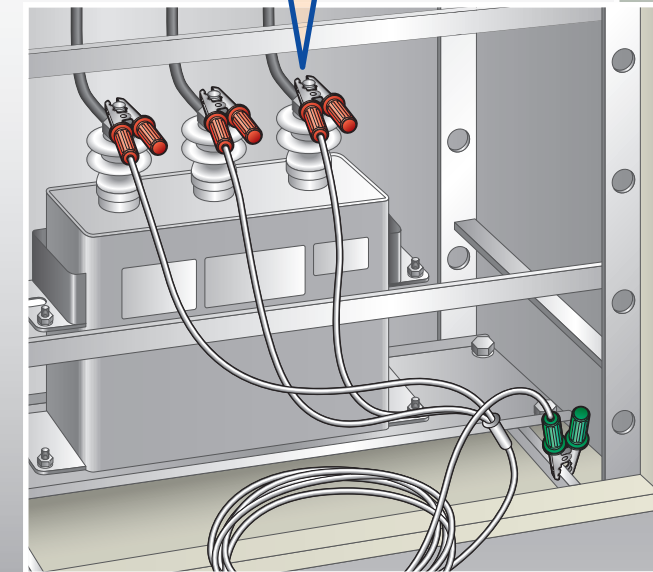

# APPLICATIONS

DC railway

**HSN-6A1**  
Voltage detector for LV and MV | **P.21**

**HVC-1.5N3(For railways)**  
Voltage detector for DC railway | **P.53**

**Grounding hook for railways** | **P.58**

**EWL-4**  
LED working light Ecopika-kun | **P.51**

# APPLICATIONS

AC railway

**HST-L series**  
Medium voltage and high voltage detector | **P.24**

**HXR-25J(For Shinkansen)**  
Medium voltage hot-line proximity detector | **P.57**

**HST-W80JS**  
Voltage detector for  
AC railway | **P.57**

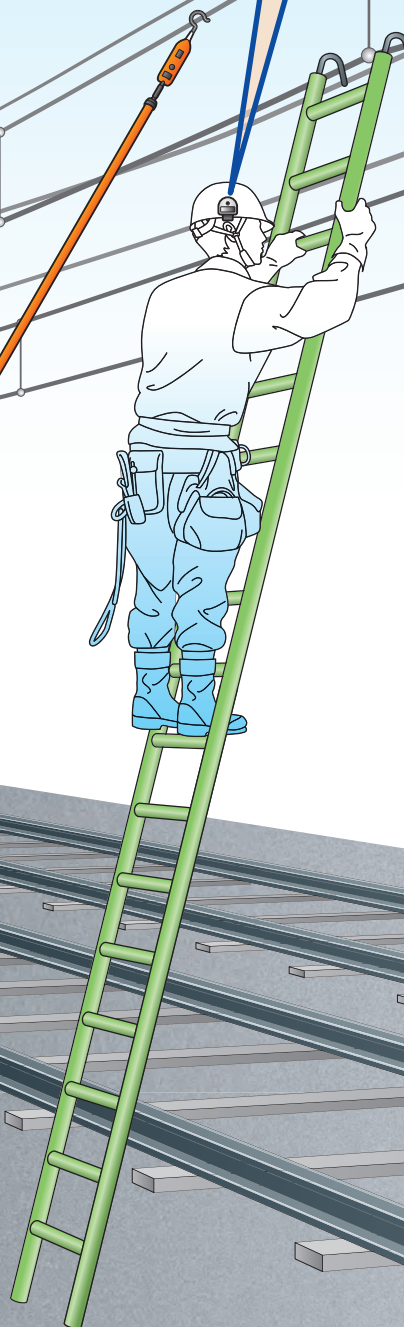
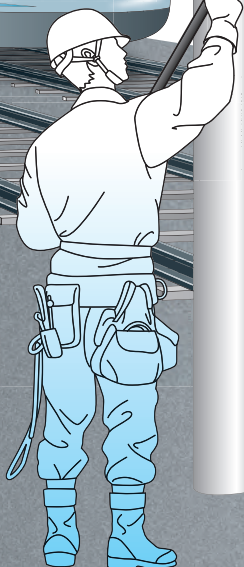
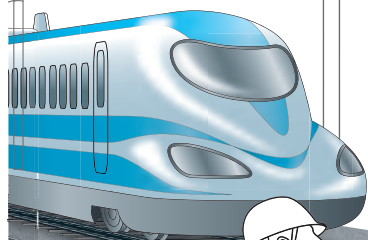

# How to read this catalog

① **HTE-610W**  
 ② Low voltage detector  
**volcheck**  
 ③ **AC 50~1000V**  
 ④ **Audio signaling and light emitting** **Contact tip Conductive rubber** **Sensitivity adjustment** **Voltage detection through covering (sheath)** **CE** **RoHS**

## Low Voltage Detector, New model coming !



### ■Features

- Highly convenient
  - Voltage detection through covering (sheath)
  - Sensitivity adjustment
- Designed with user safety and security in mind
  - Conductive rubber provides a high level of safety
  - CAT III 1000V

### ■Dimensions: HTE-610W

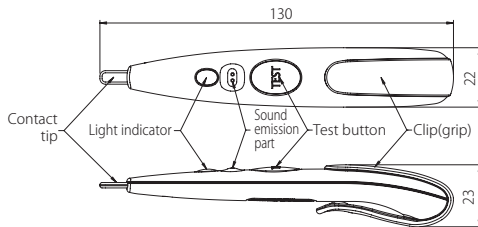

### ■Specifications

Model	HTE-610W
Working voltage range	AC50V~1000V 50/60Hz
Insulation resistance	Between contact tip and clip(grip): 100MΩ minimum with a 500V megger
Dielectric strength	Ditto:2000V-1 minute
Leakage current	Ditto:100 μ A maximum
Impulse withstand	Ditto:8000V-10 cycles of positive / negative (IEC61010-1 CAT III 1000V equivalent)
Lighting (HTE-610WL only)	The light is switched "ON" or "OFF" by pushing the test button. The light is turned off automatically about 30 seconds after the light is turned on. (Automatic power off) ※The voltage detector operator regardless of the light turned ON or OFF.
Operation starting voltage (Voltage to ground)	Maximum sensitivity: AC40V maximum Minimum sensitivity: Not operation at AC100V Operation at AC200V Ex-Factory: AC40V±10V (when the contact tip is in contact with an internal standard insulated cable (600V-IV2mm <sup>2</sup> ))
Operation status display	Light: Intermittent red light visible in 8000lx ambient Sound: Intermittent sound of 50dB minimum in 30cm distance
Operating temperature range	0°C~+40°C
Weight	22g(including batteries)
Battery	2 alkaline button cells LR44(1.5V)
Battery life	New battery : In continuous operation 10 hours : In storage 1.5 years

## ①Product type      ②Product name      ③Working voltage range

### ④Marking

<b>Audio signaling and light emitting</b> Action is notified by sound and light.	<b>AC DC</b> The product is usable for both AC and DC.	<b>Telescopic type</b> The operating rod is telescopic.	<b>CE</b> This marking is for products for the EU market, conforming relevant standard.
<b>Contact tip - Conductive rubber</b> Conductive rubber tip prevents accident of short circuit	<b>Voltage detection over insulation</b> Voltage can be detected over the insulation sheath. (Not possible for shielded cables.)	<b>Waterproof equivalent to IPX4</b> Protection against splashes	<b>RoHS</b> The marking is to confirm satisfaction of the RoHS regulation.
<b>Contact tip - made of Conductive resin</b> Short circuit prevention. Conductivity is easy to be maintained.	<b>Voltage detection over the insulation *AC only</b> Voltage detection over the insulation not possible for DC	<b>Waterproof</b> Water-resistant structure for rain and water drops	<b>IEC</b> In Conformity to IEC IEC61243-1
<b>Contact tip - Replaceable</b> Detector tips are sold	<b>only for bare wire</b> Can be used for bare conductor only. Can not be used for insulated conductor.	<b>Battery-less</b> No battery is used for operation.	
<b>Sensitivity adjustment</b> Sensitivity can be adjusted by turning the volume knob.	<b>LED lighting</b> LED lamp is equipped to light the target location of voltage detection.	<b>Auxiliary device for voltage detection</b> The product is not a voltage detector, but is used to assist voltage detection work.	

⑤Battery life -----The battery supplied with product is for testing, this battery life shall not be applied.

# Product list

## Voltage detector

◇Low voltage detector [For AC]	
HTE-610W/volcheck	15
HTE-610WL/volcheck (with LED light)	15

◇Low voltage detector [For AC/DC]	
HTE-700D/DL	17
HT-670	17

◇Voltage detector for medium & low voltages	
HSF-11	19
HSE-7G	19
HSS-25B1	20
HSG-6	20
HSN-6A1	21
HST-1.5N	21
HST-30	22
HST-70	22
HST-170	22
HST-250	22

◇Medium voltage & high voltage detector	
HST-30W	23
HWB-35	23
HWB-138	23
HWB-550	23
HST-30L	24
HST-70L	24
HST-W80L	24
HS-500	25
WM Series	25
HST-20N	26
HS-90N	26
HWA-33X	27

## Auxiliary device for voltage detection

◇Hot line proximity detector	
HXG-1	28
HXC-3K	28
HXW-6W	30
HXW-6WL	30
HXA-6	31
HXA-6S	31
HXA-30	32
HXA-30S	32
HXA-70	32
HXA-70S	32

## Voltage detector checker

HLA-1A	33
HLA-2G	33
HLA-N2	33
HLA-3	33

## Phase tester

◇For low voltage	
HPL-200	35
◇For medium voltages	
HPI-A6/S6/S20	36
HPI-S20W	37
HP-U3/S3/T3	38
HP-U6/S6/T6	38
HP-U20/S20	38
HP-22VR	38

## Grounding hook

List of fixed types	42
List of detachable types	42
Type Z	43
Type ZB	43
Type Y	43
Type YB	43
Type H	44
Type HA	44
Type C	45
Type F	45
Type S	45

## Discone hook stick

HSH-K6	46
SA109 series	46
D series	46

## Discharge stick

HRD-27S	47
HRD-27	48
Order made Discharge stick	48

## Measuring instrument

VOLTECT / Extra-High Voltage Detecting System	49
---	----

## Illuminator

EWL-4/LED working light	51
-------------------------	----

## Railway products

◇Voltage detector	
HVC-1.5N3	53
HVC-750N3	54
HVC-1.5N3S	55
HVC-1.5N3M	55
HS-1.5NJ	56
HS-1.5NR	56
HST-W80JS	57
◇Auxiliary device for voltage detection	
HXR-20J	57
HXR-25J	57
◇Grounding hook	
SA106A Series	58

Index etc.

Voltage detector

Auxiliary device for voltage detection

Voltage detector checker

Phase tester

Grounding hook

Discone hook stick

Discharge stick

Measuring instrument

Illuminator

Railway products

Information materials

# Voltage Detectors as per working voltages

## ■ For Low Voltage to Medium Voltage

Model	Feature	Voltage						Listed page
		0V 50V/100V	600V	1000V	7000V	11,400V	20000V	
HTE-610W		AC50~1000V						15
HTE-610WL	With LED lighting	AC50~1000V						15
HTE-700D/DL		AC50~600V		DC12~750V				17
HT-670	Voltage discrimination function of 100 V-200 V (* When option is used)	AC50~600V		DC50~600V				17
HSF-11		AC80~11,400V						19
HSE-7G		AC60~7,000V						19
HSS-25B1	Telescopic type	AC 80 ~ 25,000V						20
HSG-6	Telescopic type	AC80~7,000V						20
HSN-6A1	Telescopic type	AC100~7,000V				~AC10.5kV**		21
		DC50~7,000V				~DC21kV**		
HST-1.5N		AC600~7,000V				DC600~7,000V		21

## ■ For Medium Voltage to Extra High Voltage

Model	Feature	Voltage							Listed page
		3kV	6kV	22kV	66kV	154kV	275kV	500kV	
HST-30W	Telescopic type	AC3kV~42kV							23
HWB-35	Non-contact type	AC6kV~35kV							23
HWB-138	Non-contact type				AC66kV~138kV				23
HWB-550	Non-contact type					AC210kV~550kV			23
HST-30L	Telescopic type	AC3kV~34.5kV							23
HST-70L	Telescopic type				AC20kV~80.5kV				23
HST-W80L	Telescopic type				AC60kV~195.5kV				23
HS-500						AC250kV~550kV			24
WM-22	Pinwheel type /Telescopic type	AC6.6kV~22kV							24
WM-33	Pinwheel type /Telescopic type	AC6.6kV~33kV							24
WM-77A/B/C	Pinwheel type /Telescopic type	AC11kV~77kV							24
WM-154A/B	Pinwheel type /Telescopic type	AC11kV~154kV							24
WM-275	Pinwheel type /Telescopic type				AC33kV~275kV			24	
HST-20N		AC3kV~25kV							25
		DC3kV~25kV							
HS-90N				AC6kV~90kV					25
				DC6kV~90kV					
HWA-33X				AC11kV~33kV					26

## ■ For Railway (for trolley wire)

Model	Feature	Voltage				Listed page
		0V	600V	7000V	20000V	
HVC-1.5N3	Digital display Function for checking earth wire disconnection	DC1500V * Measurement range is 0 to 1999 V				53
HVC-750N3	Digital display Function for checking earth wire disconnection	DC600/750V * Measurement range is 0 to 999 V				54
HVC-1.5N3S	Digital display Function for checking earth wire disconnection	DC1500V * Measurement range is 0 to 1999 V				55
HVC-1.5N3M		DC600/750/1500V * Measurement range is 0 to 1999 V				55
HS-1.5NJ		AC6600V				56
		DC600~7000V				
HS-1.5NR	Residual electric charge checking function Standby display function	AC6600V				56
		DC1000~7000V				

Model	Feature	Voltage							Listed page
		3kV	6kV	22kV	66kV	154kV	275kV	500kV	
HST-W80JS	Telescopic type / Standby display function	AC20kV~80.5kV							57

# General Catalog of Voltage Detectors

# INDEX

How to read this catalog	11	Index etc.
List of products	12	
Voltage Detectors as per working voltages	13	
INDEX	14	
Voltage detector	15~27	Voltage detector
Auxiliary device for voltage detection	28~32	Auxiliary device for voltage detection
Voltage detector checker	33~34	Voltage detector checker
Phase tester	35~38	Phase tester
Grounding hook	39~45	Grounding hook
Disconnecter hook stick	46	Discone hook stick
Discharge stick	47~48	Discharge stick
Measuring instrument	49~50	Measuring instrument
Illuminator	51	Illuminator
Railway products (except for voltage detector, grounding hook)	52~58	Railway products
How to use the voltage detector	59~68	Information materials
Product warranty, maintenance	69~70	
In order to use the voltage detector correctly	71~74	
Confirming dead-line work	75~76	



For low voltage

For medium &amp; low voltage

For medium voltage

For medium &amp; high voltage

For extra high voltage

For AC

For DC

For AC &amp; DC

For communication

For railways

Index etc.

Voltage detector

Auxiliary device for voltage detection

Voltage detector checker

Phase tester

Grounding hook

Discharge hook stick

Discharge stick

Measuring instrument

Illuminator

Railway products

Information materials

# HTE-610W

Low voltage detector  
**volcheck**

AC 50~1000V

Audio signaling and light emitting

Contact tip  
Conductive rubber

Sensitivity adjustment

Voltage detection through covering (sheath)

CE

RoHS

## ■Features

- Highly convenient
  - Voltage detection through covering (sheath)
  - Sensitivity adjustment
- Designed with user safety and security in mind
  - Conductive rubber provides a high level of safety
  - CAT III 1000V

## ■Dimensions: HTE-610W

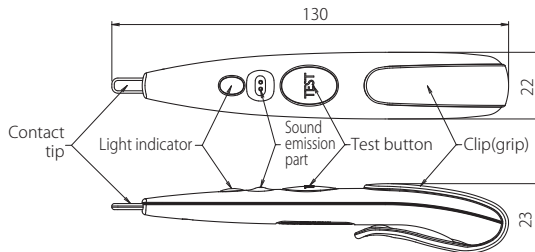

## Low Voltage Detector, New model coming !



## ■Specifications

Model	HTE-610W
Working voltage range	AC50V~1000V 50/60Hz
Insulation resistance	Between contact tip and clip(grip): 100MΩ minimum with a 500V megger
Dielectric strength	Ditto:2000V-1 minute
Leakage current	Ditto:100 μA maximum
Impulse withstand	Ditto:8000V-10 cycles of positive / negative (IEC61010-1 CAT III 1000V equivalent)
Lighting (HTE-610WL only)	The light is switched "ON" or "OFF" by pushing the test button. The light is turned off automatically about 30 seconds after the light is turned on. (Automatic power off) ※The voltage detector operator regardless of the light turned ON or OFF.
Operation starting voltage (Voltage to ground)	Maximum sensitivity: AC40V maximum Minimum sensitivity: Not operation at AC100V Operation at AC200V Ex-Factory: AC40V ± 10V (when the contact tip is in contact with an internal standard insulated cable (600V-IV2mm <sup>2</sup> ))
Operation status display	Light: Intermittent red light visible in 8000lx ambient Sound: Intermittent sound of 50dB minimum in 30cm distance
Operating temperature range	0°C ~ +40°C
Weight	22g (including batteries)
Battery	2 alkaline button cells LR44(1.5V)
Battery life	New battery : In continuous operation 10 hours : In storage 1.5 years

# HTE-610WL

Low voltage detector  
**volcheck**

AC 50~1000V

Audio signaling and light emitting

Contact tip  
Conductive rubber

Sensitivity adjustment

Voltage detection through covering (sheath)

LED lighting

CE

RoHS

## ■Features

- Highly convenient
  - Voltage detection through covering (sheath)
  - Sensitivity adjustment
- Designed with user safety and security in mind
  - Conductive rubber provides a high level of safety
  - CAT III 1000V
- LED light type with more functions
  - Built in LED light with auto power-off function
  - The LED light also serves as a battery lever checker

## ■Dimensions: HTE-610WL

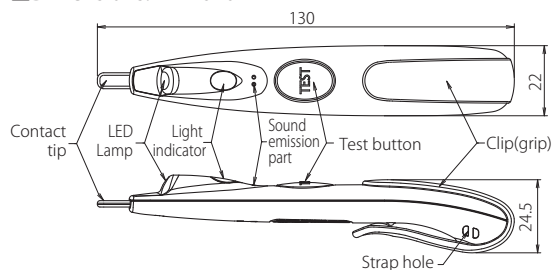

## Low Voltage Detector, New model coming !



## ■Specifications

Model	HTE-610WL
Working voltage range	AC50V~1000V 50/60Hz
Insulation resistance	Between contact tip and clip(grip): 100MΩ minimum with a 500V megger
Dielectric strength	Ditto:2000V-1 minute
Leakage current	Ditto:100 μA maximum
Impulse withstand	Ditto:8000V-10 cycles of positive / negative (IEC61010-1 CAT III 1000V equivalent)
Lighting (HTE-610WL only)	The light is switched "ON" or "OFF" by pushing the test button. The light is turned off automatically about 30 seconds after the light is turned on. (Automatic power off) ※The voltage detector operator regardless of the light turned ON or OFF.
Operation starting voltage (Voltage to ground)	Maximum sensitivity: AC40V maximum Minimum sensitivity: Not operation at AC100V Operation at AC200V Ex-Factory: AC40V ± 10V (when the contact tip is in contact with an internal standard insulated cable (600V-IV2mm <sup>2</sup> ))
Operation status display	Light: Intermittent red light visible in 8000lx ambient Sound: Intermittent sound of 50dB minimum in 30cm distance
Operating temperature range	0°C ~ +40°C
Weight	22g (including batteries)
Battery	2 alkaline button cells LR44(1.5V)
Battery life	New battery: In continuous operation 10 hours (with LED Lamp OFF) 5 hours (with LED Lamp ON) : In storage 1.5 years

## How to use the LV voltage detector for AC

### ■ Perform voltage detection while holding the grip firmly.

The contact area with the hand affects the sensitivity of the low voltage detector. So, appropriate sensitivity cannot be obtained unless it is held firmly.

● Good



● Bad



Holding only with finger tips

● Bad



Holding end of the grip

### ■ How to make contact with the detector

● Correct

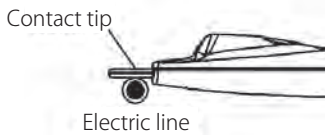

Make contact with wide side of the tip to ensure large contact area.

● Wrong

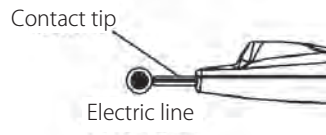

Making contact just by the end of the contact tip. (Capacitance decrease, and operating sensitivity becomes low.)

● In the case of detection on a multicore cable (two or more conductors)

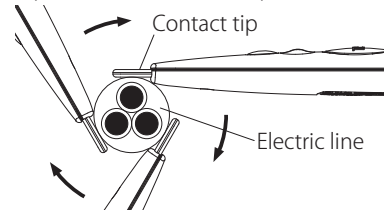

Perform voltage detection throughout the circumference.

### ■ Voltage detection for shielded cables is not possible.

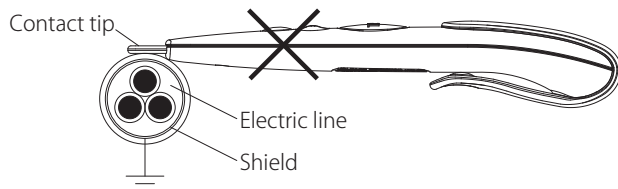

The voltage detector does not work because of the electrical shielding layer which is grounded.

### ■ Sensitivity adjustment ( for HTE-610W, HTE-610WL, HT-670 ) \* Adjustment is made by the volume knob after detaching the clip.

The products are adjusted to the standard sensitivity at shipment (as default). However, sensitivity adjustment can be made when it is required for some reasons such as: When the detection is not possible over the outer surface of the insulated cable; When it is required to reduce the influence of induced voltage of the area etc.

When the volume knob is turned to the LV side (left turn), sensitivity increases (detect lower voltage), and when turned to the HV side (right turn), sensitivity decreases (detect higher voltage).

\* The volume knob can be turned only about half a rotation. Overturning may cause damage.

\* Pay attention to excessively high or low sensitivity. If it is excessively high, there is a risk that a correct judgment would not be possible, because the product responds to too small voltage and static electricity etc.

#### ■ HTE-610W/610WL

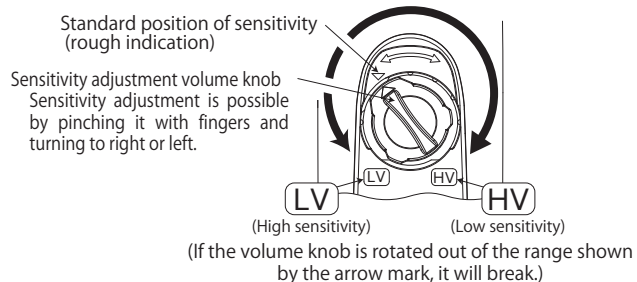

#### ■ HT-670

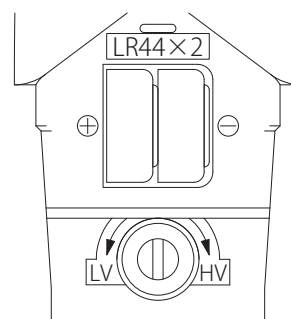

For low voltage

For medium &amp; low voltage

For medium voltage

For medium &amp; high voltage

For extra high voltage

For AC

For DC

For AC &amp; DC

For communication

For railways

# HTE-700D/DL

Low voltage detector

AC 50~600V

DC 12~750V



## ■ Features

- Waterproof equivalent to IPX4

## ■ Dimensions

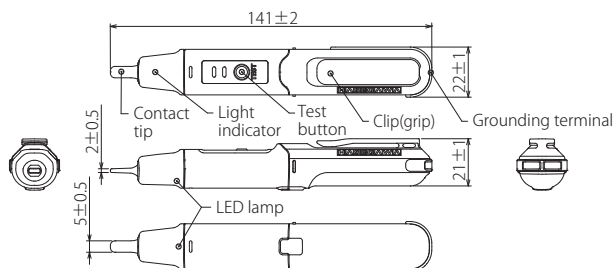

## The New release equipped waterproof as a successor of HT-680 Series



## ■ Specifications

Model		HTE-700D	HTE-700DL
Working voltage range	AC	50~600V	
	DC	12~750V	
Frequency		50/60Hz	
Operation starting voltage (Voltage to ground)		AC15V±5V DC6V±3V Hold to grounding terminal by bare hands or connect a grounding wire to the ground (company standard). AC 80V or less grounding wire is necessary to detect DC.	
function of LED light		—	○
Operation status indication	Light	Continuous light emission in red : Verifiable at 8000Lx	
	Sound	Continuous sound : 50dB or more (10cm apart)	
Operation temperature range		-10°C~+40°C	
Waterproof		equivalent to IPX4	
Battery		AAA battery (R03/LR03 1.5V) × 1pce (Can not use rechargeable battery)	
Battery life (with new battery)		about 10hr (under continuously operating state without LED) about 1.5years (in unused state)	
Weight		about 25g (except battery)	

# HT-670

Low voltage detector

AC 50~600V

DC 50~600V



## ■ Features

Sensitivity switch-over by slider switch depending on the detection (bare conductor/insulated conductor)

## ■ Option Lead wire/DF01027

- Optional lead wire can be used for
- Voltage discrimination function (discrimination of 100 V, 200 V)
- Prevents unnecessary detection due to reverse induction voltage (Lead wire should be contacted to grounded metal)

## ■ Dimensions

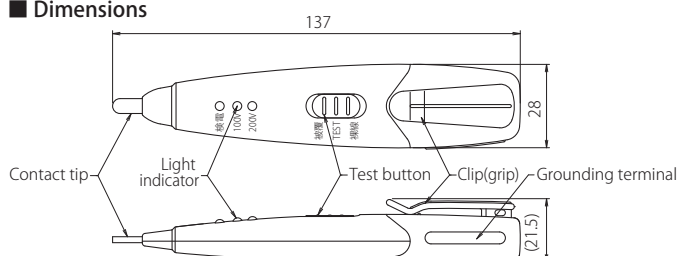

## Switchable sensitivity (AC only)



## ■ Specifications

Model		Without lead wire	With lead wire	
Working voltage range	AC	50~600V		
	DC	50~600V		
Frequency		50/60Hz		
Operation starting voltage (Voltage to ground)	Coated wire (sheathed wire)	AC	40 V with insulated wire (IV. 2 mm2) (intermittent operation)	
		DC	—	
	Bare wire	AC	30 ± 15 V (continuous operation)	
		DC	30 ± 15 V (continuous operation)	
(At connection of lead wire)	AC	100 V LED light	30 V ± 20 V (continuous operation)	
	DC	200 V LED light	140 V ± 30 V (continuous operation)	
Battery		LR44(1.5V) × 2 pcs		
Battery life		About one year with normal use		
Weight		26g (except lead wire)		

\* Without the casing

## How to use the LV Voltage Detector for DC

(For AC, refer to P.16.)

### Key points of DC voltage detection

When carrying out voltage detection with a DC circuit, the current does not flow through the capacitance, unlike the case of an AC circuit. Therefore, DC voltage detection becomes possible when the DC current flows through the detector by contacting the detector to an exposed charged conductor (\*①), connecting the earth terminal to the ground (\*②) and therefore creating a closed circuit (\*③).

- ① Voltage detection is not possible over the insulation. (Direct touch of contact tip to an exposed live part is necessary.)
- ② It is necessary to connect the Grounding terminal to earth with lead wire (option of HT-670) and/or with the free hand not holding the voltage detector.

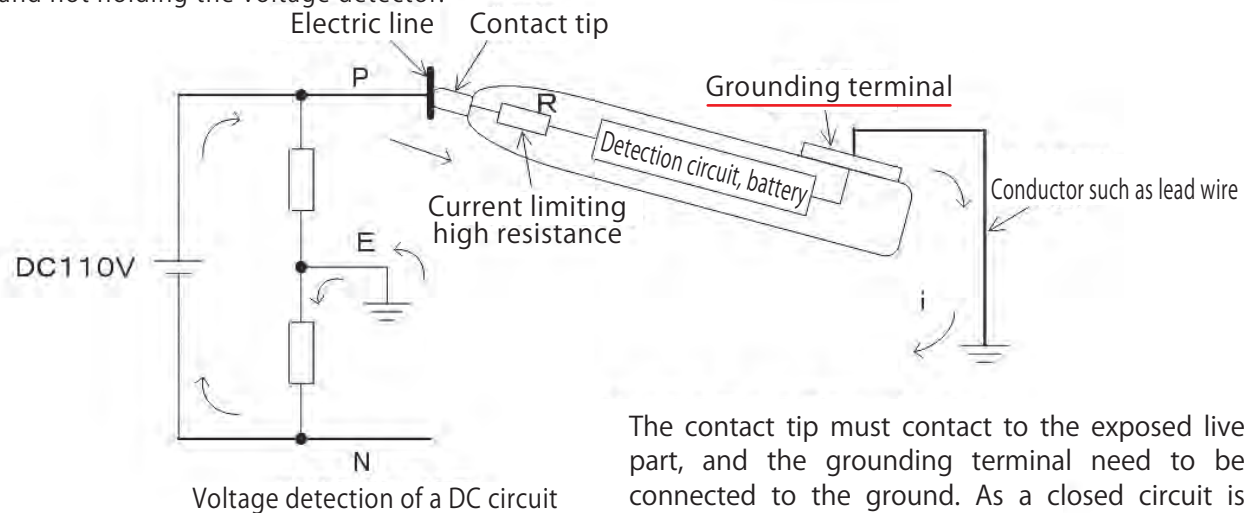

- ③ Since the detected voltage between the live part and ground is depending on the condition of connection from grounding terminal to earth, it is necessary to understand about the circuit formed for detection. (cf. Voltage detection for un-earthed circuit is not possible.)

\* When HT-670 lead wire is used, the line-to-line voltage can be checked.

(Pay sufficient attention to the handling of lead wires. There is a risk of electric shock and/or short-circuit if misused.)

[Mid-point grounding type]

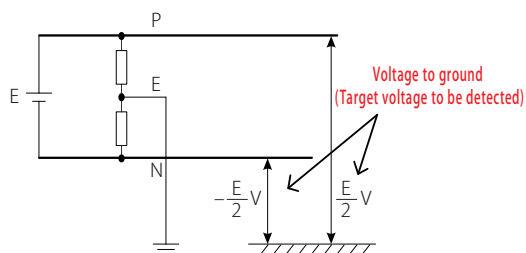

[Ungrounded type]

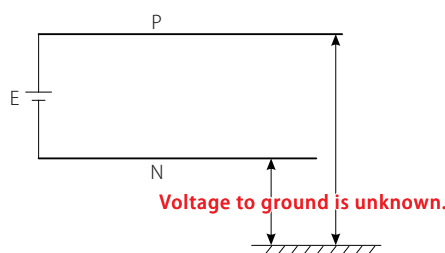

\* Voltage detection is not possible.

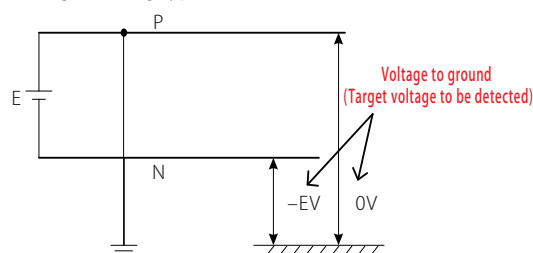
[One-side line grounding type]  
+ side grounding type

\* No detection for Grounded plus (+) side.

Minus (-) side grounding type

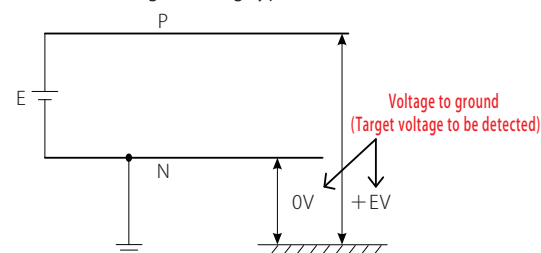

\* No detection for Grounded minus (-) side.

# HSF-11

Voltage Detector for Medium/Low voltage

AC 80~11.4kV



### ■ Features

- Extremely small and light weighted, so easy to handle and carry.
- Voltage detection can be done by both light and sound, so no misconception happens.
- Testing system is equipped to Voltage Detector itself.
- By inner electric circuit, consumption is saved when not used.

### ■ Dimensions

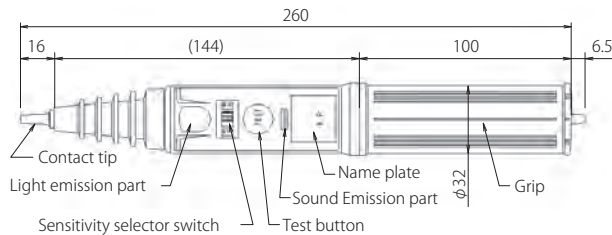

## Standard Model for 11.4kV



### ■ Accessory



Storage case

### ■ Specifications

Working voltage range	AC80~11.4kV	
Operation starting voltage (Voltage to ground)	Low voltage	Exposed live part 65 ± 15V (in contact with live part)
	High voltage	Exposed live part 2000 ± 200V (in contact with live part)
Electric line	For Bare wire only	
Frequency	Both 50Hz and 60Hz	
Insulation resistance	100MΩ or more between the contact tip and the grip	
Dielectric strength	20kV for 1minutes between the contact tip and the grip	
Leakage current	0.1 mA or less on dielectric strength	
Operation status display	Light emission	Verifiable at 8000 Lx of brightness(Red LED)
	Sound emission	50 dB or more (2m apart)
Operating temperature range	-10°C~+40°C	
Waterproof	Equivalent to IPX3 (No harmful water entering inside)	
Battery	R03(1.5V) 2pcs	
Battery life	About 6 hr. under continuously operating state (with new battery)	
Weight	About 150 g	

# HSE-7G

For communication

Voltage detector for Medium/Low voltage

AC 60~7000V



### ■ Features

- Working voltage range from AC 60V as per Telecom standard in Japan
- Successor of HSC-7G (certified product as per NTT spec.)

### ■ Dimensions

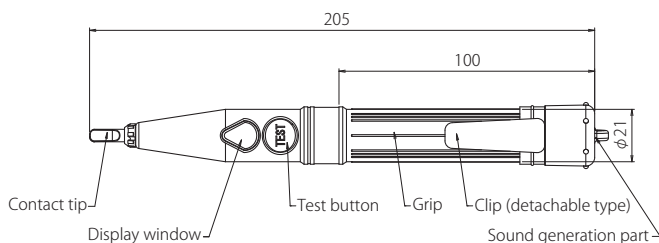

## Recommended for Telecom workers on the pole



### ■ Accessory



Storage case

### ■ Option



Contact tip for replacement (UH05004)

### ■ Specifications

Working voltage range	AC60V~7000V	
Operation starting voltage (Voltage to ground)	Low voltage	Exposed live part 60 V (in contact with live part)
	High voltage	Exposed live part 400 V (in contact with live part)
	Insulated wire	(φ5mm OE wire) 3,000 V
Frequency	50/60Hz	
Dielectric strength	20 kV for 1 min between contact tip and grip	
Leakage current	0.5 mA or less at dielectric strength test	
Battery	LR44(1.5V) × 2 pcs	
Battery life	3 hr. in continuously operating state; about 2 years in unused state	
Operating temperature range	-10°C~+40°C	
Weight	About 55 g	

# HSS-25B1

Voltage detector for Medium/Low voltage

**AC 80~25000V**

## Telescopic type, Standard model for Medium Voltage



- Audio signaling and light emitting
- Telescopic type
- Waterproof

### ■ Features

- Voltage detection from a remote place is possible by extending it
- \* Low voltage cannot be detected on stick extension mode.

### ■ Dimensions

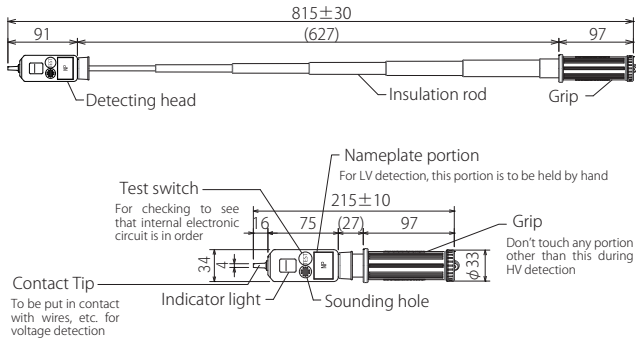

### ■ Accessory



Storage case

### ■ Detecting at low voltage



### ■ Specifications

Working voltage range	AC80~25000V	
Operation starting voltage (Voltage to ground)	Low voltage	Bare wire : AC 80V or below (Detect holding nameplate portion)
	High voltage	Bare wire (φ3mm) : AC 250V ± 50V OC wire (φ5mm) : AC 1000V ± 200V (Detect holding the grip)
Frequency	50/60Hz	
Dielectric strength	Between contact tip and grip: Extended state 50 kVAC, 1 min	
	Between contact tip and name plate portion: 4 kVAC, 1 min	
Leakage current	0.1 mA or less at dielectric strength test	
Battery	LR44(1.5V) × 2 pcs	
Battery life	8 hr. in continuously operating state; about 1.5 years in unused state	
Operating temperature range	-10°C ~ +50°C	
Weight	About 140 g	

# HSG-6

Voltage detector for Medium/Low voltage

**AC 80~7000V**

## Telescopic Type, Lightweight and Compact



- Audio signaling and light emitting
- Contact tip Conductive rubber
- Contact tip Replaceable
- Telescopic type
- Waterproof

### ■ Features

- Super-compact and lightweight, 85g
- The contact tip made of conductive rubber is replaceable.
- Medium voltage and low voltage can be identified with the indication (Sound/Light).
- Low voltage detection is indicated by intermittent sound & light and medium voltage is indicated by continuous sound & light.
- \* Low voltages cannot be detected on stick extension mode.

### ■ Dimensions

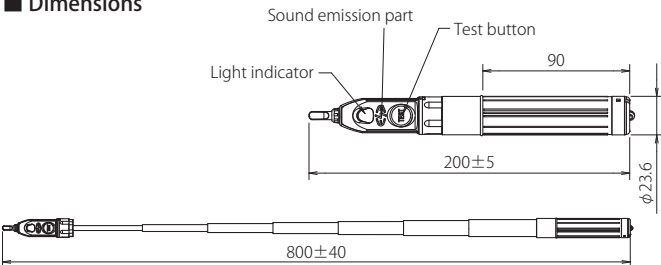

### ■ Option



Storage case (DA04003)



Contact tip for replacement (UH05003)

### ■ Specifications

Working voltage range	AC80~7000V	
Operation starting voltage (Voltage to ground)	Low voltage	Exposed live part 80 V (Operating rod is at a shortened state.)
	High voltage	Exposed live part 400 V (Operating rod is at a shortened state.)
	Insulated wire	(φ5mm OC wire) 3,400 V
Frequency	50/60Hz	
Dielectric strength	Between contact tip and grip: Shortened state 20 kVAC, 1 min	
Leakage current	0.5 mA or less at dielectric strength test	
Battery	LR44(1.5V) × 2 pcs	
Battery life	8 hr. in continuously operating state; about 1.5 years in unused state	
Operating temperature range	-10°C ~ +40°C	
Weight	About 85 g	

- Index etc.
- Voltage detector
- Auxiliary device for voltage detection
- Voltage detector checker
- Phase tester
- Grounding hook
- Discharge hook stick
- Discharge stick
- Measuring instrument
- Illuminator
- Railway products
- Information materials

# HSN-6A1

Voltage detector for Medium/Low voltage

- AC** 100 to 7000 V (at withstand voltage test of 10.5 kV)
- DC** 50 to 7000 V (at withstand voltage test of 21 kV)

- Audio signaling and light emitting
- Telescopic type
- AC DC
- Waterproof

### Features

- It can be used for withstand voltage tests with high-voltage equipment. It can be used up to 10.5 kVAC, 21 kVDC, only for application of withstand voltage test.
- Discriminate AC and DC
- Checking residual electric charge, and discharging it. (Refer to P.66.)

### Dimensions

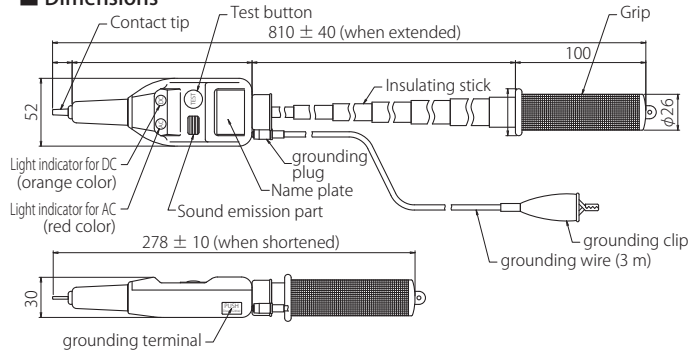

## Recommended for Withstand Voltage Test



### Accessory



Storage case



grounding wire (3 m)

### Detecting at low voltage

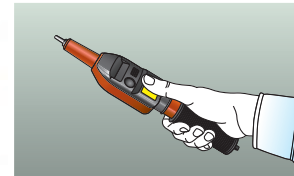

### Specifications

Working voltage range	Without grounding wire	AC	100 V to 600 V (Voltage detection by touching the name plate with a hand) 3 kV to 7 kV (With extended insulating stick)
	With grounding wire	AC	100 V to 7000 V (Usable up to 10.5 kV for withstand voltage test)
		DC	50 V to 7000 V (Usable up to 21 kV for withstand voltage test)
Frequency (AC)			50/60Hz
Leakage current	Between contact tip and name plate		4 kVAC, 1 min, 1 mA or less
	Between contact tip and grip		(Insulating stick: Shortened) 20 kVAC, 1min, 100 μA or less (Insulating stick: Extended) 50 kVAC, 1min, 100 μA or less
	Between contact tip and grounding clip		26 kVAC, 1 min, 1 mA or less
	Between core of the grounding plug and outside the covering		22 kVDC, 1 min
Battery			LR44(1.5V) × 2 pcs
Operating temperature range			-10°C ~ +50°C
Weight			About 290 g

# HST-1.5N

Medium voltage detector

- AC** 600~7000V
- DC** 600~7000V

- Audio signaling and light emitting
- AC DC
- Waterproof

### Features

- With 7-m grounding wire

### Dimensions

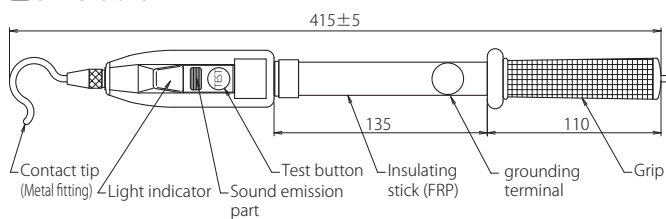

## Robust and Lightweight, FRP for Insulating Stick



### Accessory



Bag for housing



grounding wire (7 m)

### Specifications

Working voltage range	AC	600V~7000V
	DC	
Frequency		50/60Hz
Dielectric strength		Between contact tip and grounding terminal 14000 VAC, 5 min
Leakage current		1 mA or less at dielectric strength test
Battery		LR44(1.5V) × 2 pcs
Battery life		4 hr. under continuously operating state
Operating temperature range		-10°C ~ +40°C
Weight		About 340 g (main body only)

# HST series

## HST-30/HST-70/HST-170/HST-250

Medium voltage & High voltage detector

AC	HST-30	3kV~ 34.5kV
	HST-70	20kV~ 80.5kV
	HST-170	60kV~195.5kV
	HST-250	150kV~287.5kV

- Audio signaling and light emitting
- Telescopic type
- Waterproof

### ■ Features

- FRP is used for the insulating stick. It is lightweight and outstanding in operability.
- Tip metal fitting consists of a shock-absorbing spring.

### ■ Dimensions

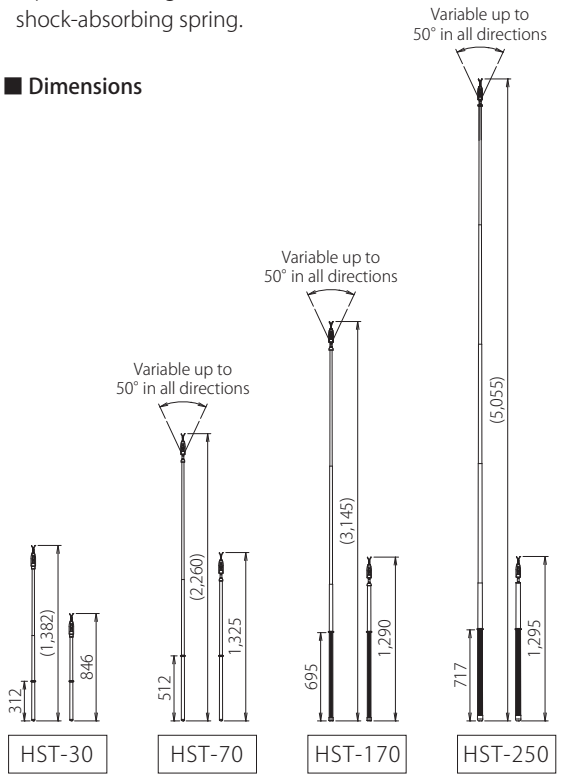

For Medium voltage and High voltage, light weight and easy to use



Because the angle at the detector is adjustable, it can be set up so that the light emission is easy to see. (HST-70, HST-170, HST-250)

### ■ Accessory



HST-30 (Shortened state)   HST-170 (Shortened state)

■ Operating rod can be changed to a longer one. (\* Changing to a shorter one is not possible from the viewpoint of safety.)

Model	Standard product	Model after changing the operating rod		
		Changed to operating rod of HST-70 (2,260 mm)	Changed to operating rod of HST-170 (3,145 mm)	Changed to operating rod of HST-250 (5,055 mm)
HST-30		HST-30G	HST-30H	HST-30J
HST-70		—	HST-70H	HST-70J
HST-170		*	—	HST-170J



(for HST-V series) Universal joint compatible

### ■ Specifications

Model	HST-30	HST-70	HST-170	HST-250
Working voltage range	AC 3kV~34.5kV	20kV~80.5kV	60kV~195.5kV	150kV~287.5kV
Operation starting voltage (Voltage to ground)	Bare wire 500V±20% φ5mm-OC wire 3 kV or less	3kV±20%	10kV±20%	20kV±20%
Frequency	50/60Hz			
Dielectric strength	Contact tip – Grip 70 kVAC, 1 min	Insulating stick 75 kVAC/300 mm, 1 min (following positions except for the electrode and joint portions)		
Leakage current	100 μA or less at dielectric strength test/1 position			
Battery	LR44(1.5V) × 2 pcs			
Battery life	About 4 hr. under continuously operating state			
Operating temperature range	-10°C~+50°C			
Weight	About 340 g	About 530 g	About 600 g	About 1030 g

- Index etc.
- Voltage detector
- Auxiliary device for voltage detection
- Voltage detector checker
- Phase tester
- Grounding hook
- Discharge stick
- Measuring instrument
- Illuminator
- Railway products
- Information materials



# HST-30W

Audio signaling and light emitting type voltage detector

**AC** 3kV~42kV



### ■ Features

- FRP is used for the insulating stick. It is of lightweight and has outstanding operability.
- Tip metal fitting consists of a shock-absorbing spring.

### ■ Specifications

Working voltage range	AC3kV~42kV	
Operation starting voltage (Voltage to ground)	AC 500 ± 100 V (bare wire)	
Frequency	50/60Hz	
Dielectric strength	On insulating rod AC 75kV/300mm for 1minute. (2 places)	
Insulation resistance	The same points as those of dielectric strength. 2,000 MΩ or more	
Leakage current	0.1 mA or less on dielectric strength	
Operating temperature range	- 10°C ~ +50°C	
Operation status display	Light	Verifiable at 8000 Lx of brightness (Red LED)
	Sound	50dB or more (3m apart)
Waterproof	There should be no water seeping inside after applying precipitation of 3 mm/min to the detection part for 10 minutes.	
Battery	LR44(1.5V) x 2 pcs	
Weight	About 340 g	

### ■ Dimensions

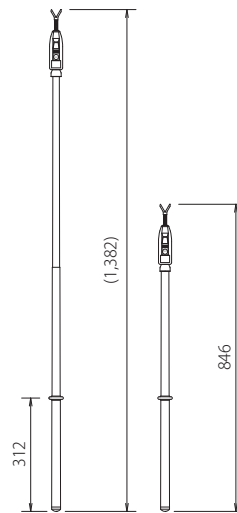

### ■ Accessory



# HWB series

Non-contact voltage detector

**AC** HWB-35 6kV~ 35kV  
HWB-138 66kV~138kV  
HWB-550 210kV~550kV



### ■ Features

- FRP is used for the insulating stick. It is of light-weight and has outstanding operability.
- Universal joint type

### ■ Specifications

Model	HWB-35	HWB-138	HWB-550
Working voltage range	AC 6~35kV	AC 66~138kV	AC 210~550kV
Operation distance	5 ~ 10cm (at AC 6kV)	5 ~ 10cm (at AC 66kV)	5 ~ 10cm (at AC 210kV)
Indication	Sound	Intermittent sound 80dB or more	
	Light	Stand-by state : Green LED light (Automatically turns off in about 2minutes) Operation state : Red LED flash light (Flashing red light, distinguishable in brightness of 50,000lux)	
Frequency	50/60Hz		
Water proof	Equivalent to IP45		
General design	Separate device		
Shock resistance	This device has Shock resistance by Pendulum method (Pendulum method: IEC 61243-1 Shock resistance)		
Operating temperature range	- 10°C ~ +50°C		
Battery	R03 (1.5V) × 2pcs.		
Weight	About 400 g (Include batteries)		
Accessory	Bag for housing		

### ■ Dimensions

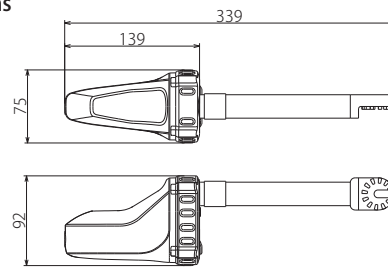

# HST-L series

HST-30L/HST-70L/HST-W80L  
Medium voltage & High voltage detector

AC	HST-30L	3kV~34.5kV
	HST-70L	20kV~80.5kV
	HST-W80L	20kV~80.5kV

## Long length for Feeder

- Audio signaling and light emitting
- Telescopic type
- Waterproof

### Features

- FRP is used for the insulating stick. It is lightweight and outstanding in operability.
- Tip metal fitting consists of a shock-absorbing spring.



Contact tip



Extended state

80L

### Dimensions

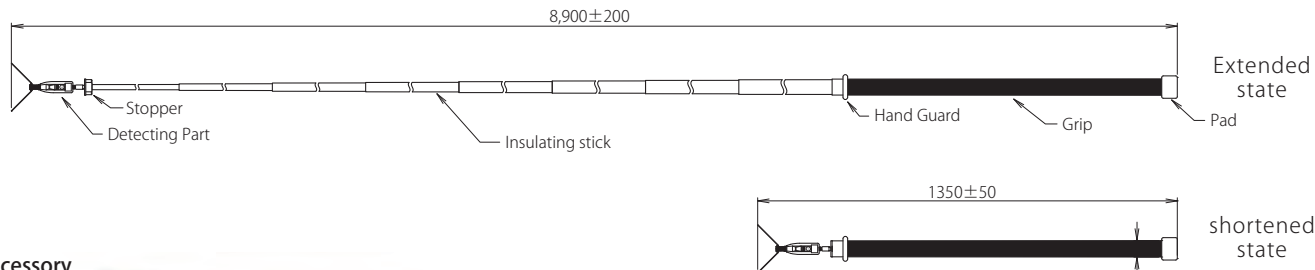

### Accessory



Bag for housing (DA14006)

### Specifications

Type		HST-30L	HST-70L	HST-W80L
Working voltage range	AC	3kV~34.5kV	20kV~80.5kV	20kV~80.5kV
Operation starting voltage	AC	500V ± 100V	3,000V ± 600V	5,000V ± 1,000V
Frequency		50/60Hz		
Dielectric strength		on insulating stick AC 75kv/300mm for 1 minute. (insulating stick excluding contact tip and joint)		
		1 place	3 places	3 places
Leakage current		0.1mA or less during dielectric strength test (1 place)		
Battery		LR44(1.5V) × 2 pcs		
Life of the battery		About 4 hr. under continuously operating state		
Operating temperature range		-10°C ~ +50°C		
Weight		About 3kg	About 3kg	About 3kg

- Index etc.
- Voltage detector
- Auxiliary device for voltage detection
- Voltage detector checker
- Phase tester
- Grounding hook
- Discharge hook stick
- Discharge stick
- Measuring instrument
- Illuminator
- Railway products
- Information materials

# HS-500

Extra high voltage detector

AC 250k~550kV

## Voltage Detector for 500 kV Transmission Lines



- Audio signaling and light emitting
- Telescopic type
- Waterproof

### ■ Features

- Voltage detector for the highest voltage T/L in Japan
- Sound and light indications can be confirmed outdoors in daytime, even in high level of noise.

### ■ Accessory



Bag for housing

### ■ Dimensions

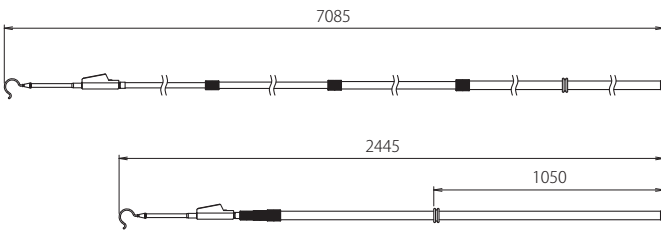

### ■ Specifications

Working voltage range	AC250kV~550kV
Operation starting voltage (Voltage to ground)	20 kVAC ± 20% (in contact with exposed live part)
Dielectric strength	Insulation pole 75 kVAC/300 mm, 5 min
Leakage current	100 μA or less at dielectric strength test/1 position
Battery	6R61 or 6F22(9V) × 1 pcs
Operating temperature range	-10°C~+50°C
Weight	About 4.7 kg

# WM series

WM-22/WM-33/WM-77A/WM-77B  
WM-154A/WM-77C/WM-154B/WM-275

Pinwheel type voltage detector

AC 6.6k~500kV

## Voltage Detection Check with Rotation of Pinwheel.



Contact tip (Metal fitting): Spring

- Telescopic type
- Waterproof
- Battery-less

### ■ Features

- Battery-less voltage detector operating with energy to be detected.

### ■ Specifications

model No.	Working Voltage Range (kV)	Length / parts (m)	quantity of parts	Length[Max] (m)	Length[Min] (m)	rod diameter (φ)	Weight (g)
22	6~ 22	0.7	2	1.51	0.91	20	340
33	6~ 33	1.0	2	2.11	1.21	20	440
77A	11~ 77	1.0	2	2.11	1.21	20	430
77B	11~ 77	1.2	2	2.51	1.41	20	490
77LB	11~ 77	1.3	2	2.71	1.51	20	530
77C	11~ 77	1.2	3	3.65	1.41	25	780
154A	11~154	1.0	3	3.04	1.21	25	660
154B	11~154	1.3	3	3.95	1.51	25	840
154D	11~154	1.2	4	4.78	1.41	30	1140
154E	11~154	1.2	5	5.81	1.41	35	1520
275	33~275	1.2	4	4.78	1.41	30	1130
275E	33~275	1.2	5	5.81	1.41	35	1510
275F	33~275	1.2	6	7.03	1.42	40	2030
500LF	154~500	1.3	6	7.61	1.52	40	2170
500G	154~500	1.2	7	8.16	1.42	45	2560

# HST-20N

Medium voltage detector

**AC 3k~25kV**  
**DC 3k~25kV**



- Features**
- New model with reduced weight of HS-20N

**■ Dimensions**

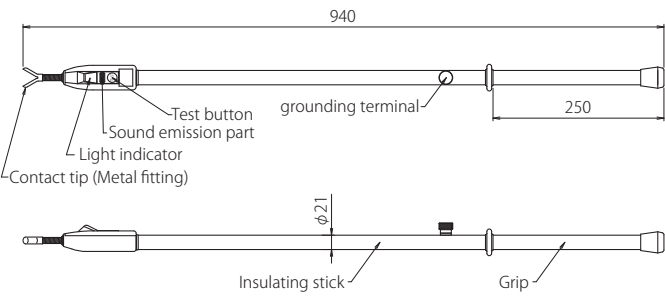

## Voltage Detector of Dual Use for AC/DC



**■ Accessory**



**■ Specifications**

Working voltage range	AC	3kV~25kV
	DC	
Operation starting voltage (Voltage to ground)	AC	1000V±20%
	DC	
	Insulated wire	
Frequency	50/60Hz	
Dielectric strength	Between contact tip and grounding terminal, AC 50kV, 1 min	
Leakage current	0.5 mA or less at dielectric strength test	
Battery	LR44(1.5V) × 2 pcs	
Battery life	About 4 hr. in a continuously operating state	
Operating temperature range	-10°C~+40°C	
Weight	About 610 g (main body only)	

# HS-90N

Medium voltage and High voltage detector

**AC 6k~90kV**  
**DC 6k~90kV**



- Features**
- It operates over wide range from medium voltages to high voltages

**■ Dimensions**

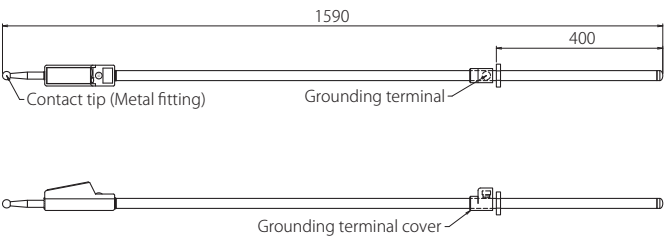

## Wide Range type for both AC and DC



**■ Accessory**



**■ Specifications**

Working voltage range	AC	6~90kV
	DC	
Operation starting voltage (Voltage to ground)	AC	1000V±20%
	DC	
Frequency	50/60Hz	
Dielectric strength	Between contact tip and grounding terminal, AC 180kV, 5 min	
Leakage current	1 mA or less at dielectric strength test	
Battery	6R61 or 6F22(9V) × 1 pcs	
Operating temperature range	-10°C~+50°C	
Weight	About 1,400 g (main body only)	

Index etc.

Voltage detector

Auxiliary device for voltage detection

Voltage detector checker

Phase tester

Grounding hook

Discharge hook stick

Discharge stick

Measuring instrument

Illuminator

Railway products

Information materials

For low voltage

For medium &amp; low voltage

For medium voltage

For medium &amp; high voltage

For extra high voltage

For AC

For DC

For AC &amp; DC

For communication

For railways

# HWA-33X

High voltage detector

AC 11kV~33kV



IEC61243-1

## ■ Features

Customizable tips:

Tip fittings can be changed to hook type, straight type, Y-shaped type, etc

Multi-functional display:

It has a 3-step light and sound function to notice approaching the target voltage in a non-contact state.

In addition, when the detector is applied to the changing point, the lamp lights up in red to indicate the detector result in an easy-to-understand manner.

Universal joint:

Universal joint type for easy connection to shared control rods.

## ■ Dimensions

191 mm × 79 mm × φ64 mm

\*Length of the Y-shaped contact tip (metal fitting): 27 mm

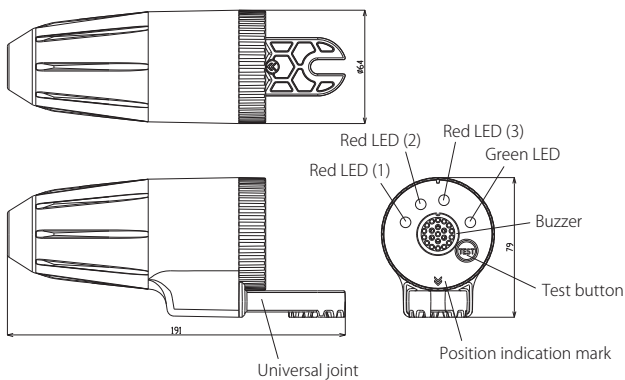

Universal joint

Position indication mark

Red LED (2)

Red LED (1)

Red LED (3)

Green LED

Buzzer

Test button

Position indication mark

Red LED (2)

Red LED (1)

Red LED (3)

Green LED

Buzzer

Test button

Universal joint

Position indication mark

## ■ Specifications

Applicable voltage	11 kV to 33 kV AC	
Frequency	50/60 Hz	
Climate category	Category N: Temperature of -25 to +55°C, Humidity of 20 to 96%	
Waterproofness	Equivalent to IPX4	
Operation status display (Audio signaling and light emitting)	<b>■ Display group: III</b> - Standby display: Green LED On (Switched off automatically in 1 minute) - Hot Line Proximity Detector display (for nominal voltage of 11 kV) Stage 1: Standard distance operation start: 60 cm ± 10 cm Operation status display: Flashing Red LED (1) and intermittent buzzer sound (Flashing/Sound interval: Once/sec) Stage 2: Standard distance operation start: 30 cm ± 10 cm Operation status display: Flashing Red LEDs (1) (2) and intermittent buzzer sound (Flashing/Sound interval: Twice/sec) - Live-part indication: Operation starting voltage (in contact with Contact tip) : 3.3 kV to 4.95 Kv Operation status display: Red LEDs (1) (2) (3) On and continuous sound (- Abnormality display: Red LEDs (1) (2) (3) On, Green LED On and indefinite sound) - Sound volume: 70 dB or more	
	Continuous operation	About 3 hours
	Self-inspection	Check the battery level and operation status display using the operation test.
	Battery	AAA alkaline batteries (LR03 1.5 V): 2 pieces *Use of rechargeable batteries not allowed
	Weight	About 350 g (excluding the contact tip)
	Accessory	Storage case

IEC61243-1 standard voltage detectors are finally here !



Customizable tips



Multi-functional display



Universal joint



# HXG-1

Portable live part detector

AC 3.3kV ~ 77kV

Audio signaling and light emitting

Waterproof

Auxiliary device for voltage detection

**[Attention]**

This device is not a voltage detector.

## Determine whether the Substation Facilities are charged



■ Accessory



Storage case

■ Specifications

Working voltage range	3.3 kV to 77 kV	
Operating temperature range	-10°C ~ +40°C	
Frequency	50/60Hz	
Battery	LR44(1.5V) × 2 pcs	
Dielectric strength	Between contact tip and grip: Extended state 20 kVAC, 1 min	
Detection performance	Operation Voltage-Distance: 3.3kV - 0.2m * Operation Voltage-Distance are theoretical value.	
Operation status display	Light	Can be confirmed at the distance of 50 cm in the luminance of 8,000 lux.
	Sound	50dB or more (1m apart)
Weight	85g	

■ Voltage & distance to be separated, and detectable distance

Voltage (kV)	3.3	6.6	11	22	33	66	77
Detectable distance (m)	0.2	0.5	1.0	1.7	2.2	2.9	3.0

Operation distance is varied depending on the actual surrounding environment.  
Please confirm operation distance in actual use environment before using.

# HXC-3K

Portable live part detector

AC 3.3kV ~ 77kV

Audio signaling and light emitting

Waterproof

Auxiliary device for voltage detection

**[Attention]**

This device is not a voltage detector.

## Determine whether the Substation Facilities are charged



■ Specifications

Working voltage range	3.3 kV to 77 kV (Non-contact type for 11 kV or higher)	
Operating temperature range	-20°C ~ +40°C	
Frequency	50/60Hz	
Battery	LR44(1.5V) × 2 pcs	
Dielectric strength	Between tip part and grip of detector 20 kVAC, 1 min (Leakage current: 1 mA or less)	
Detection performance	Operation starting voltage: 400 V ± 20% Detectable distance: 5 cm at 3.3 kV, 10 cm at 6.6 kV	
Operation status display	Light	Can be confirmed at the distance of 50 cm in the luminance of 8,000 lux.
	Sound	50dB or more (1m apart)
Dimensions	155mm	
Weight	35g	

\* Without the casing

■ Voltage & distance to be separated, and detectable distance

Voltage (kV)	3.3	6.6	11	22	33	77
Necessary distance to be separated (cm)	—	—	15	25	35	76
Detectable distance (cm)	5	10	33	90	120	230

■ Features

- Compact size and lightweight make it convenient to carry

Index etc.

Voltage detector

Auxiliary device for voltage detection

Voltage detector checker

Phase tester

Grounding hook

Discone hook stick

Discharge stick

Measuring instrument

Illuminator

Railway products

Information materials

# Hot line proximity detector

Auxiliary voltage detection device that gives alarm sounding at a distance when approach to a live line.

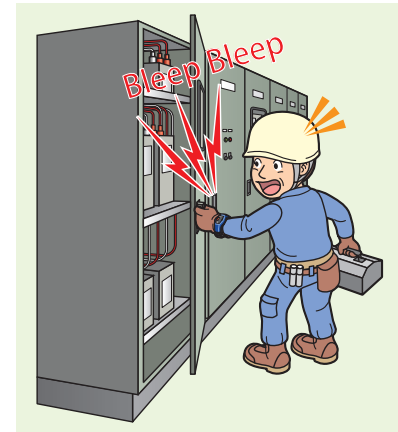
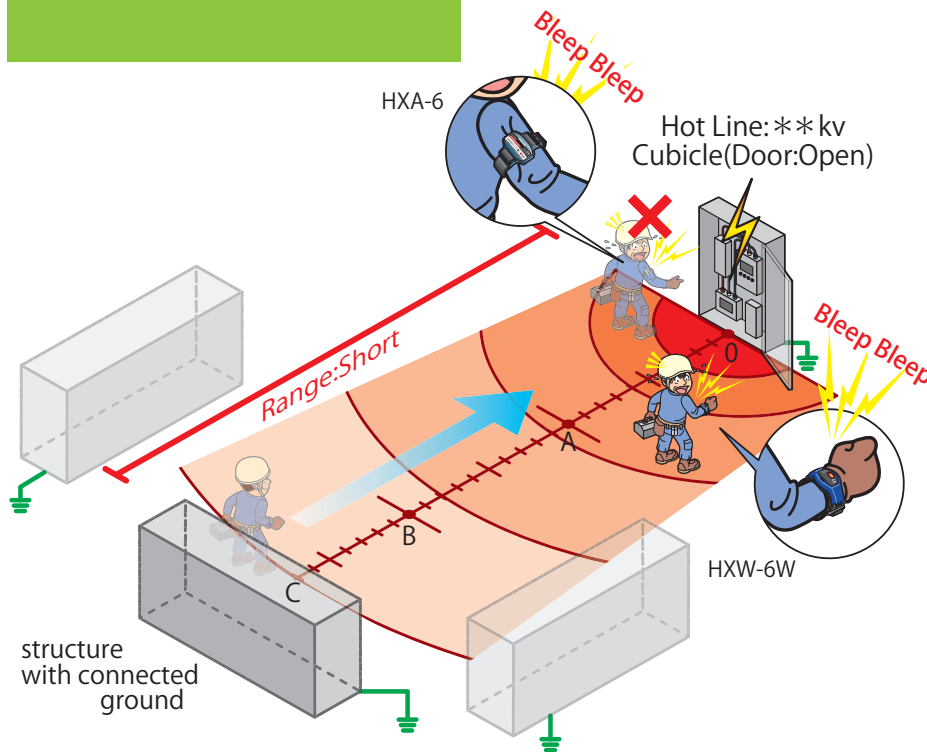

## Hot line proximity detector

### What is a Hot line proximity detector?

- It is a product that generates an alarm when it detects a voltage at a distance to prevent accident of electric shock. Unintended access due to human errors such as preconception or misconception can be prevented.
- This product cannot be used as a voltage detector.

### Precautions before purchasing the Hot line proximity detector

- Please use proper model according to the applications, because detection sensitivity has been adjusted for cubicle works and overhead line works respectively assuming the general site conditions.
- The specification "○V-○cm" of this product is a distance under the "standard condition" set in the factory. At actual sites, the operation distance may become shorter, depending on environment, wiring conditions, etc. (\*1)  
(\*1) e.g.: When a grounded structure exists nearby, etc.
- The sensitivity of this product is directional. Sensitivity is reduced at the back of the product (in the case of HXW-6W, direction of the palm).

#### Image of operating distance

Detection is easier in the direction of fingertips and lateral direction.

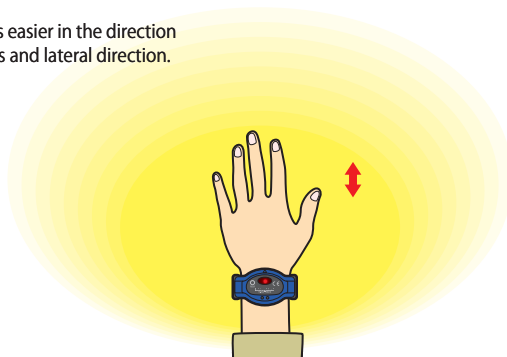

In the direction of the palm, the detecting distance is shorter than in the upper direction.

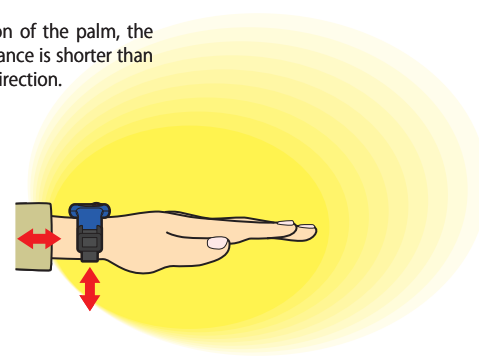

# HXW-6WL

WRIST ALARM

AC 400V to 22kV



### Specifications

Model	HXW-6WL
Working Voltage range	400V to 22kV
Standard distance for operation	25cm against 400V (230V to ground) * Under Hasegawa's standard conditions.
Frequency	Both 50Hz and 60Hz
Sound volume	65dB or more (60cm apart)
Battery	Coin type Lithium battery (CR1620) 1 piece
Operating temperature range	-10°C ~ +40°C
Dimensions	(W) 77mm × (D) 40mm × (T) 14mm
Weight	About 35g

### Operation Voltage Distance Table (Theoretical value)

Normal Voltage	Operation Distance
0.4kV	0.25m
1kV	0.4m
6.6kV	1.0m
11kV	1.3m
22kV	1.9m

Applicable from low voltage to high voltage



### Operation Voltage Distance graph (Theoretical value)

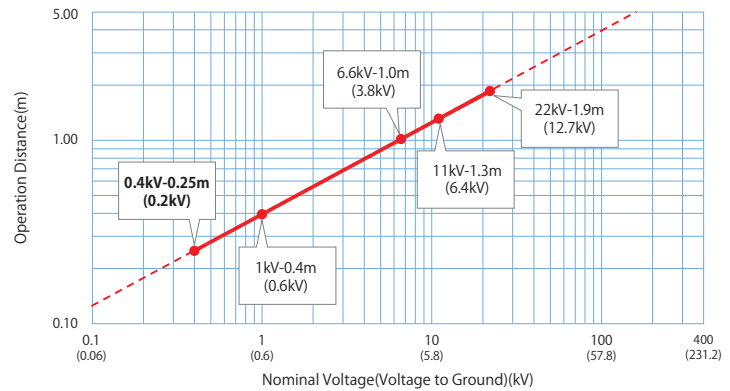

Operation Voltage-Distance Table and graph are theoretical value.

Operation distance is varied depending on the actual surrounding environment.

Please confirm operation distance in actual use environment before using.

\* When used with overhead distribution lines, the operating distance will be longer.

\* HXW-6WL is the customized model which is specialized in detecting low voltage.

It may begin to operate at longer distance than necessary when using in the field of Mid-High voltage.

If it may begin to operate at longer distance than necessary, consider using theoretical model.

# HXW-6W

(Both 50Hz and 60Hz)

WRIST ALARM

AC 1kV to 42kV



### Specifications

Model	HXW-6W
Working Voltage range	1kV to 42kV
Alarm starting distance (Under standard condition)	60cm against 6.6kV (3.8kV to ground)
Frequency	Both 50Hz and 60Hz
Sound volume	65dB or more (60cm apart)
Battery	CR1620 (3V) × 1pcs
Battery life (with new battery)	Continuously operating state: About 15 hr. Unused state: About 10 months
Operating temperature range	-10°C ~ +40°C

### Operation Voltage Distance Table (Theoretical value)

Normal Voltage	Operation Distance
6.6kV	0.6m
11kV	0.8m
22kV	1.1m
33kV	1.3m

Exclusively for cubicle works



### Operation Voltage Distance graph (Theoretical value)

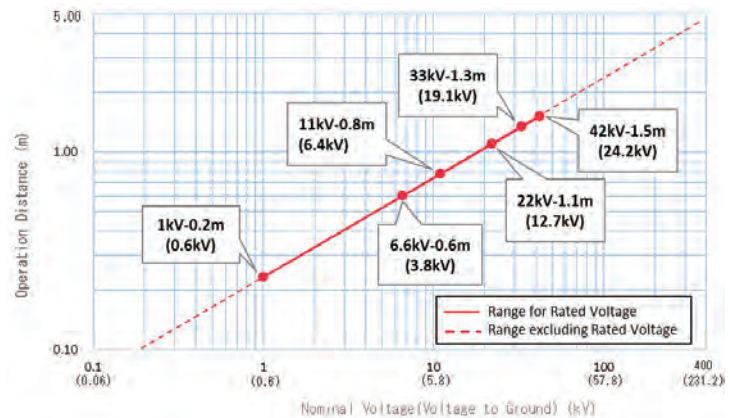

Operation Voltage-distance table and graph are theoretical value.

Operation distance is varied depending on the actual surrounding environment.

Please confirm operation distance in actual use environment before using.

Index etc.

Voltage detector

Auxiliary device for voltage detection

Voltage detector checker

Phase tester

Grounding hook

Discone hook stick

Discharge stick

Measuring instrument

Illuminator

Railway products

Information materials



# Hot line proximity detector

Auxiliary voltage detection device that gives alarm sounding at a distance when approach to a live line.

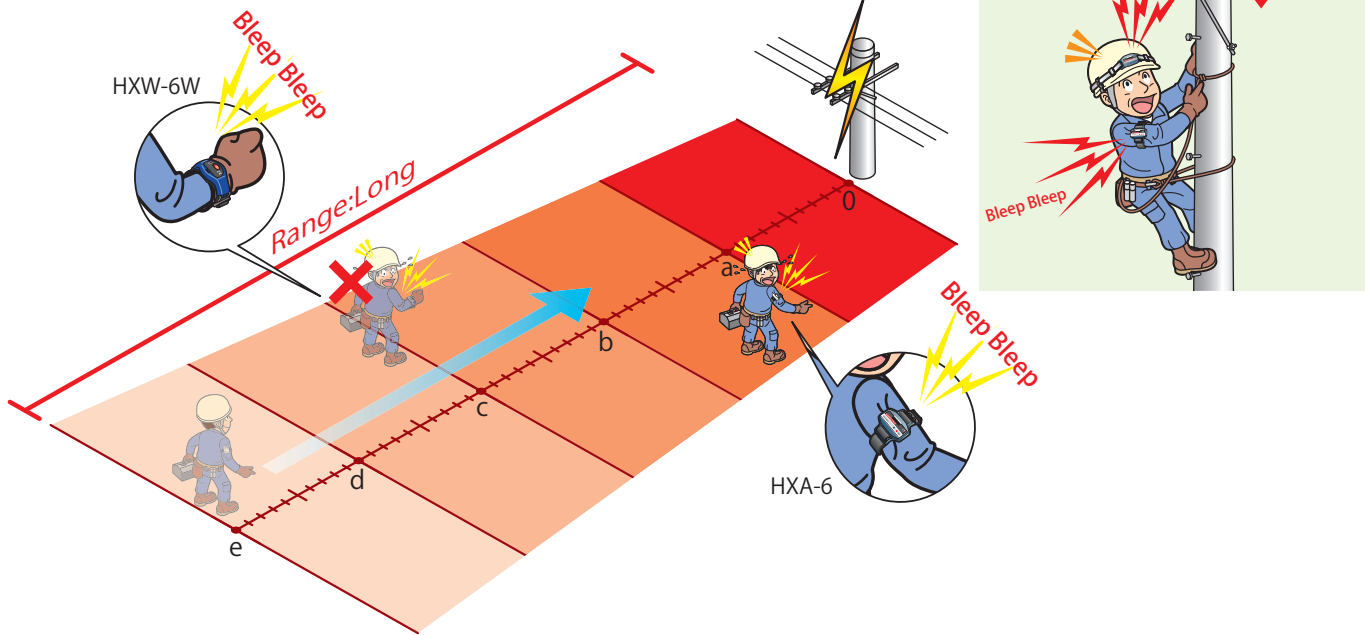

## HXA-6 HXA-6S

AC 11kV



HXA-6 (Upper arm fitting type) HXA-6S (Helmet fitting type)



Hot line proximity detector exclusively for overhead line works

**[Attention]**  
This is not suitable for cubicle works.

### Specifications

Model	HXA-6	HXA-6S
Location of use	Exclusive for work with overhead lines	
Alarm starting distance (Under standard condition)	80cm	110cm
Frequency	Either 50 Hz or 60 Hz, whichever is designated	
Sound volume	65dB or more (1m apart)	
Battery	JIS CR2032(3V) × 1 pcs	
Battery life (with new battery)	Continuously operating state	About 50 hr.
	Unused state	About 2 years
Operating temperature range	-10°C ~ +40°C	

### Operation Voltage Distance Table (Theoretical value)

Normal Voltage (kV)	Operation Distance	
	HX-6	HX-6S
6.6kV	0.8m	1.1m
11kV	1.0m	1.4m
22kV	1.5m	2.0m
33kV	1.8m	2.5m

### Operation Voltage Distance graph (Theoretical value)

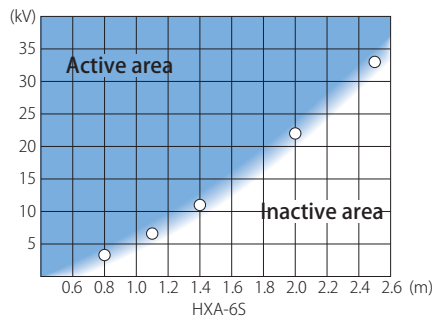
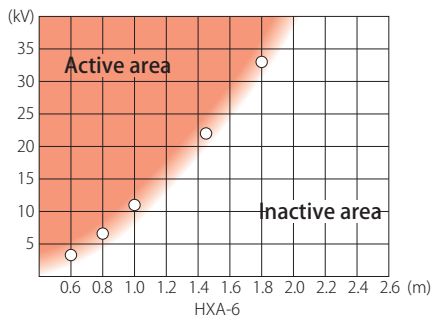

Operation Voltage-distance table and graph are theoretical value. Operation distance is varied depending on the actual surrounding environment. Please confirm operation distance in actual use environment before using.

# HXA-30 HXA-30S

AC 33kV



HXA-30 (Upper arm fitting type) HXA-30S (Helmet fitting type)



## Hot line proximity detector exclusively for overhead line works

\* Please designate the frequency (50 Hz or 60 Hz).

**[Attention]**

This is not suitable for cubicle works.

### Specifications

Model	HXA-30	HXA-30S
Standard operation start distance	11kV (Voltage to ground: 6.4 kV) - 70 cm (under normal conditions)	11 kV (Voltage to ground: 6.4 kV) - 100 cm (under normal conditions)
Frequency	50 Hz / 60 Hz	
Sound volume	65 dB or more	
Battery for use	JIS CR2032 (3V) x 1	
Allowable temperature range	-10°C to +40°C (with no surface or internal condensation)	
Water resistance	Equivalent to IPX4	
Weight	About 45 g (body only)	
External dimensions	(W) 78 × (D) 82 × (T) 25	(W) 94 × (D) 48 × (T) 27.5
Accessories	Fixing band	Fixing band, Holder (2pcs)

### Operation Voltage Distance Table (Theoretical value)

Normal Voltage	Operation Distance	
	HXA-30	HXA-30S
11kV	0.7m	1.0m
22kV	0.9m	1.4m
33kV	1.2m	1.7m

Operation Voltage-distance table and graph are theoretical value.

Operation distance is varied depending on the actual surrounding environment.

Please confirm operation distance in actual use environment before using.

### Operation Voltage Distance graph (Theoretical value)

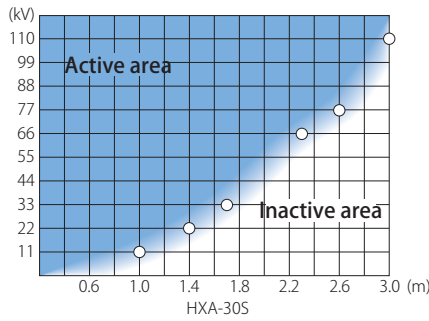
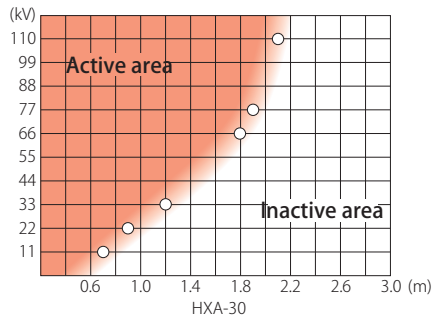

# HXA-70 HXA-70S

AC 77kV



HXA-70 (Upper arm fitting type) HXA-70S (Helmet fitting type)



## Hot line proximity detector exclusively for overhead line works

\* Please designate the frequency (50 Hz or 60 Hz).

**[Attention]**

This is not suitable for cubicle works.

### Specifications

Model	HXA-70	HXA-70S
Standard operation start distance	66 kV (Voltage to ground: 38 kV) - 150 cm (under normal conditions)	66 kV (Voltage to ground: 38 kV) - 150 cm (under normal conditions)
Frequency	50 Hz / 60 Hz	
Sound volume	65 dB or more	
Battery for use	JIS CR2032 (3V) x 1	
Allowable temperature range	-10°C to +40°C (with no surface or internal condensation)	
Water resistance	Equivalent to IPX4	
Weight	About 45 g (body only)	
External dimensions	(W) 78 × (D) 82 × (T) 25	(W) 94 × (D) 48 × (T) 27.5
Accessories	Fixing band	Fixing band, Holder (2pcs)

### Operation Voltage Distance Table (Theoretical value)

Normal Voltage	Operation Distance	
	HXA-70	HXA-70S
66kV	1.5m	2.1m
77kV	1.6m	2.2m
110kV	1.9m	2.7m

Operation Voltage-distance table and graph are theoretical value.

Operation distance is varied depending on the actual surrounding environment.

Please confirm operation distance in actual use environment before using.

### Operation Voltage Distance graph (Theoretical value)

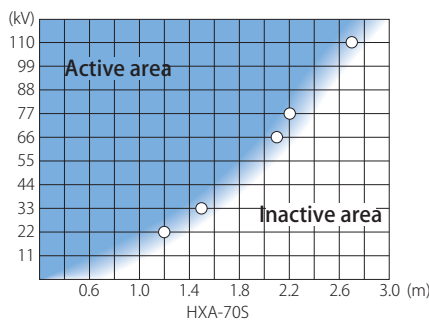
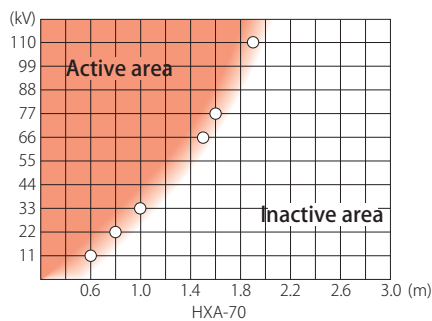

Index etc.

Voltage detector

Auxiliary device for voltage detection

Voltage detector checker

Phase tester

Grounding hook

Discharge hook stick

Discharge stick

Measuring instrument

Illuminator

Railway products

Information materials

## HLA-1A

Voltage detector checker

### Handy Type with Built-in Battery



#### ■Features

- Easy to use at the site
- Checking low/high voltage is possible.
- Compact size and lightweight make it convenient to carry

#### ■Specifications

Output voltage	H terminal ----- 400 VAC L terminal ----- 100 VAC
Output frequency	55Hz ±10Hz
Short-circuit current	0.5 mA or less
Operating temperature range	-10°C ~ +50°C
Battery	LR03(1.5V) × 4 pcs Battery life ----- Total operating time: About 1 hr.
Dimensions	65mm × 120mm × 40mm
Weight	430g

## HLA-2G

Voltage detector checker

### Handy Type with Built-in Battery



#### ■Features

- Ideal for checking voltage detectors for communication use

#### ■Specifications

Output voltage	H terminal ----- 1,200 VAC L terminal ----- 70 VAC
Output frequency	55Hz ±10%
Short-circuit current	0.5 mA or less
Operating temperature range	0°C ~ +50°C
Battery	6R61 or 6F22(9V) × 2 pcs Battery life ----- Total operating time: About 2 hr.
Dimensions	80mm × 150mm × 50mm
Weight	700g

## HLA-N2

DC voltage detector checker

### Handy Type with Built-in Battery



#### ■Features

- Exclusive use for DC high voltage detector (Optimum for HS-1.5NR & HS-1.5NJ voltage detectors)

#### ■Specifications

Output voltage	DC1000V
Load resistance	50 MΩ or more
Short-circuit current	0.5 mA or less
Operating temperature range	-10°C ~ +50°C
Battery	LR03(1.5V) × 4 pcs
Dimensions	72mm × 114mm × 45mm
Weight	280g

## HLA-3

Voltage detector checker

### Handy Type with Built-in Battery



#### ■Features

- Recommend for CL-1-06
- Handy type with built-in battery

#### ■仕様

Output voltage	4,000 V AC ±15%
Output lamp	Red LED (If the battery is low, turn off the lamp)
Output frequency	55 Hz ±10 Hz
External dimensions	100mm × 200mm × 70mm
Short-circuit current	0.5 mA or lower
Weight	About 1,200g (battery not included)
Operating temperature range	0°C to +50°C
Built-in battery	9V (6LR61 or 6LF22) x 2 pcs Life of the battery: cumulative operating hours of approx. 2 hours *6F22 batteries are not usable.

Information materials	Railway products	Illuminator	Measuring instrument	Discharge stick	Discone hook stick	Grounding hook	Phase tester	Voltage detector checker	Auxiliary device for voltage detection	Voltage detector	Index etc.
-----------------------	------------------	-------------	----------------------	-----------------	--------------------	----------------	--------------	--------------------------	--	------------------	------------

# HPL-200

Low voltage phase checker  
Insulated wire clamping type

**AC 80~600V (Three-Phase)**

**Global first\*!**

**This one unit can be used for both in-phase and different phase checks**

\* As of June 2015, own company investigation



## ■ Features

- Live-part display function: Differentiates charging status (voltage to ground of 80 V or higher) and clip connection failure
- Non-contact type: Phase rotation and in-phase/different phase can be checked from above insulated cables
- Electric line size: Wide range from 2 mm<sup>2</sup> - 100 mm<sup>2</sup> (Finished external diameter ø2.8 mm - 22 mm)
- The magnet attached on the rear of the product makes hands-free checking possible

## ■ Specifications

Applicable circuits	3-phase 3-line system and 3-phase 4-line system
Working voltage range	AC 80 V to 600 V (Sine wave, continuous) 45~66Hz
Dielectric resistance	100 MΩ or more, using 500 V megger (Between clip and case)
Dielectric strength	AC 2,000 V, one minute (Between clip and case)
Leakage current	During dielectric strength testing, 100 μA or less
Power supply display	Red LED × 1 (Automatic power OFF approx. 5 minutes)
Sound volume	50 dB or more (50 cm apart)
Battery	LR03(1.5V) × 2 Continuous use approx. 15 hours
Electric line	IV, DV, OW 2 mm <sup>2</sup> to 100 mm <sup>2</sup> (Finished external diameter ø2.8 mm to 22 mm)
Weight	About 190 g (including batteries)

## ■ Indications

Charge indication	LED color	Charged state (Voltage to ground of 80 V or higher) R (Yellow), S (Yellow), T (Yellow)	
	LED indication	Lighting	—

\*1 If voltage to ground is 80 V or lower    \*2 If ground phase or open-phase

Phase rotation indication	LED Flashing/Color	Positive rotation	Reversed rotation
	Buzzer sound	—	Intermittent sound

In-phase and different phase indication (Charge indication)	LED color	In-phase	Different phase
		LED indication	Flashing R (Yellow), S (Yellow), T (Yellow)

※Display of two clips used, light off when unused

## ■ Example indications

a) 3-phase 3-line system (200 V)

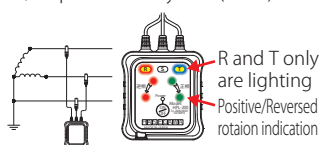

b) 3-phase 4-line system (100 V/200 V)

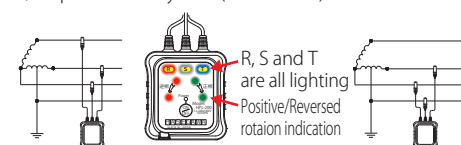

c) 3-phase 4-line system (400V)

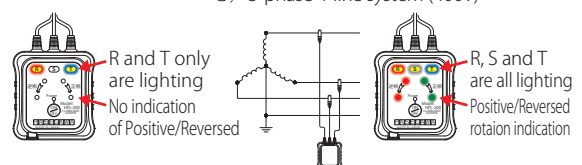

## ■ Connection method for in-phase and different phase checks

Electric meter replacement work without power cut  
(Phase test before in-phase attachment of bypass cable)

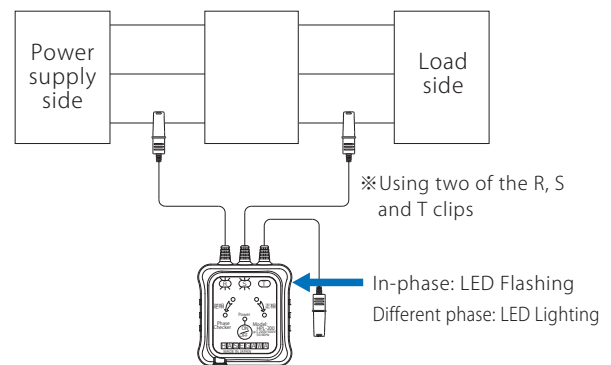

## ■ Dimensions

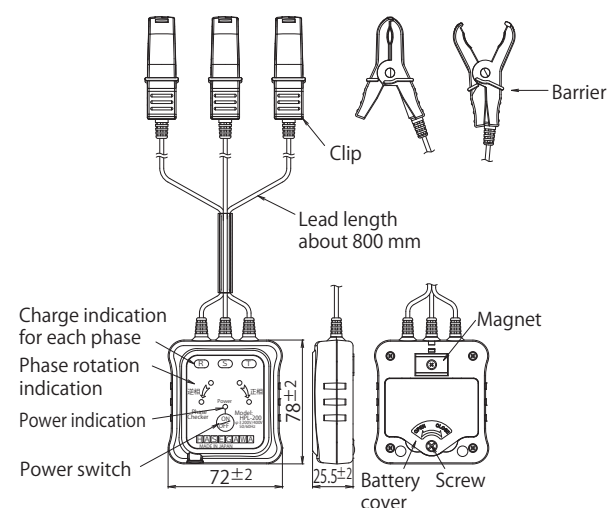

# HPI-A6/S6/S20

Medium voltage phase tester,  
Optical fiber type

- HPI-A6 AC 3kV~7kV
- HPI-S6 AC 6.6kV
- HPI-S20 AC 22kV~34.5kV

## Detector pairs insulated with optical fiber

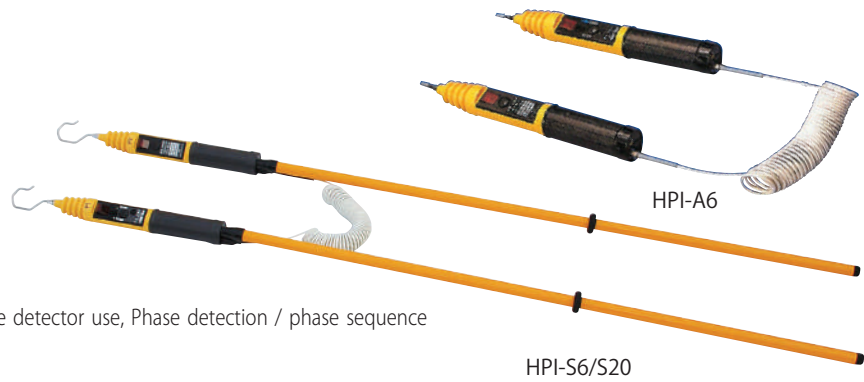

### ■Features

- Multi-functional phase tester: Voltage Detection by single detector use, Phase detection / phase sequence check with pair detector use
- Measurement is possible on the insulated wire sheath.  
Testing operation is possible through voltage detection terminals or on the wire insulation. \* Cannot be used on the shielded cable.
- In-phase/different phase, and phase sequence are indicated by sound and light indications.

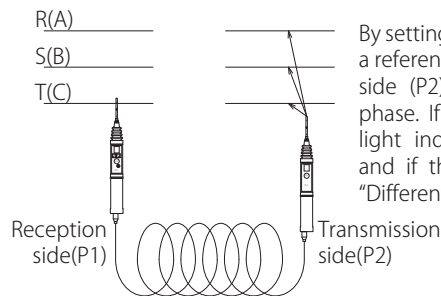

By setting the reception side (P1) as a reference, check the transmission side (P2) corresponding to each phase. If there are no sound and light indications, it is "In-phase," and if there are indications, it is "Different phase."

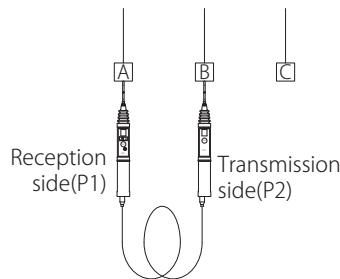

When detectors contact two out of three phases, and if there are no sound and light indications at the reception side (P1), this indicates "positive rotation," and if there are, this indicates "inverse rotation."

### ■Accessory

Storage case



HPI-A6



Bag for housing  
HPI-S6/S20

Contact tip (Metal fitting)



Hook type×2 pcs  
Flat plate type×2 pcs  
HPI-A6  
HPI-S6/S20

Insulating stick



×2pcs  
HPI-A6

Optical cable



×2pcs  
HPI-A6  
HPI-S6/S20

Joint for optical cable



HPI-A6  
HPI-S6/S20

### ■Dimensions

HPI-A6

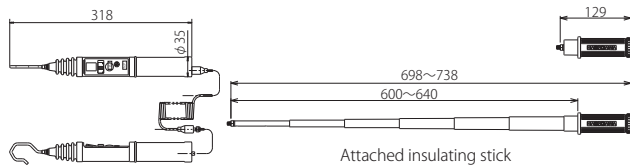

HPI-S6/S20

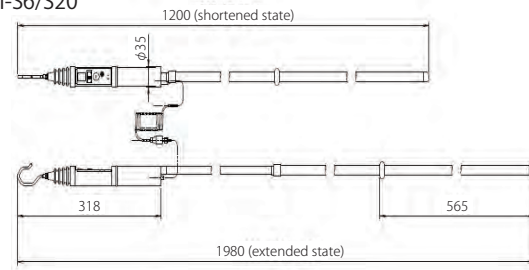

### ■Specifications

Model	HPI-A6	HPI-S6	HPI-S20
Working voltage range	3kV~7kV	6.6kV	22kV~34.5kV
Target	For cubicles	For overhead lines	
Frequency	50/60Hz		
Insulation resistance	2000MΩ or more		
Dielectric strength	20 kV, 1 min	75 kV, 1 min	
Operating temperature range	-10°C~+40°C		
Indication of operation	Light	It shall be able to confirm luminance of 8,000 lux.	
	Sound	50 dB or more at a distance of 1 m from the sound-generating part (intermittent sound generation)	
Phase test function	Detection of in-phase or different phase of 120°		
Phase sequence function	Detection of advance or delay of 120°		
Possible distance of phase test	Distance between transmitter and receiver, with standard optical cable: 6 m (3m×2) It can be used at up to 30 m with the optional optical cable.		
Battery	R1(1.5V), each 2 pcs		

### ■Option

Optical fiber cable



- 10m (DF01066-1)
- 20m (DF01066-2)
- 30m (DF01066-3)

\* Use extended with a joint is not possible.

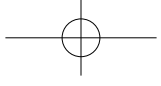

Index etc.
Voltage detector
Auxiliary device for voltage detection
Voltage detector checker
<b>Phase tester</b>
Grounding hook
Discone hook stick
Discharge stick
Measuring instrument
Illuminator
Railway products
Information materials

# HPI-S20W

Medium voltage phase tester,  
Optical fiber type

**AC 22~42kV**

## Detector pairs insulated with optical fiber



### ■Features

- FRP is used for the insulating stick. It is lightweight and outstanding in operability.
- Working voltage is wider than HPI-S20.

### ■Accessory

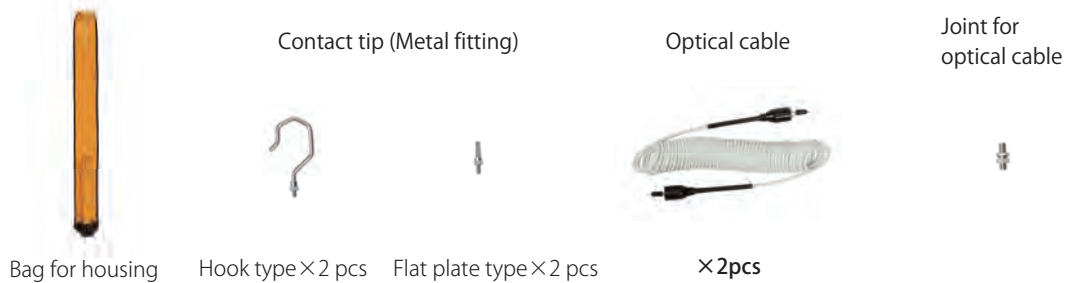

### ■Dimensions

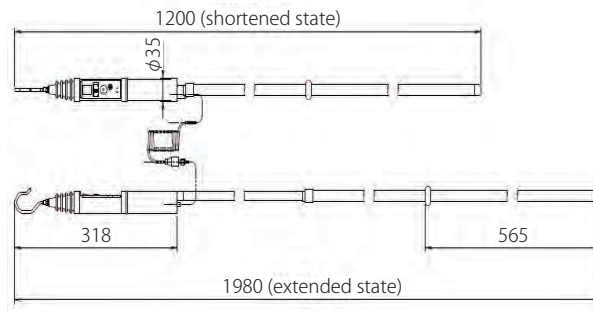

### ■Specifications

Target	For overhead lines
Working voltage range	22 kV - 42 kV
Operation starting voltage	1500 V ±20%
Dielectric strength	Between insulating sticks 30 cm apart (75 kVAC, 1 minute)
Leakage current	2 places.
Storage case	Portable case for storage
Frequency	50/60 Hz
Insulation resistance	2000 MΩ or more (Use of a 1000 V megger)
Phase test function	Detection of in-phase or different phase of 120°
Phase sequence function	Detection of advance or delay of 120°
Indicators	Light: 50 dB or more at distance of 1 m from sound source (intermittent sound) (only on receiver side)
	Sound: -10°C - +40°C
Operating temperature range	6 m (3 m × 2) distance between transmitter and receiver with standard optical cables
Distance for phase test	Up to 30 m with the optical cable option
Battery	Two 1.5 V dry batteries (R1) each
Accessories	
Storage case	Portable case for storage
Insulating stick	Telescopic type: Approx. 1,665 mm, 2 pcs
Contact tip hardware	Two metal hooks for suspension (attached at shipment)
	Two flat blades
Optical cable	3 m coiled cord x 2 pcs
Optical cable joint	1 piece

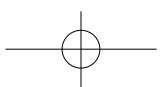

# HPseries

Medium voltage phase tester  
Wireless type

AC 3.3kV~33kV

## Easy-to-use with Wireless pair

Awarded 40th  
Shibusawa Prize



Model HP-U: Complete type



Model HP-S: Straight type

### ■ Accessory

Model HP-T: Bag for housing  
Model HP-S: Bag for housing  
Model HP-U: Trunk case

### [Attention]

There is no phase sequence (phase rotation) checking function.  
(Only indicating in-phase, different phase)  
Please designate frequency of 50 Hz or 60 Hz.

### ■ Specifications

Model	HP-T3	HP-S3	HP-U3	HP-T6	HP-S6	HP-U6	HP-S20	HP-U20	
Working voltage range	3.3kV			6.6kV			Common use for 22 kV, 33 kV		
Frequency	50 Hz or 60 Hz (Either one is to be designated.)								
Phase test function	Discrimination of in-phase or different phase of 120° * Attention: There is no phase sequence (phase rotation) function.								
Possible distance of phase test	Distance between transmission side and reception side: Within 5 m								
Total length	When extended	550mm	1220mm	1480mm	550mm	1220mm	1480mm	1220mm	3470mm
	When shortened (without telescopic structure)		850mm	1090mm		850mm	1090mm	850mm	1640mm
Indication of operation	Light	It shall be able to confirm in the luminance of 8,000 lux.							
	Sound	50 dB or more at a distance of 3 m							
Battery	6R61 or 6F22(9V), each 1 pcs								
Operating temperature range	-10°C~+50°C								
Structure	Waterproof								
Weight	700g×2	900g×2	1250g×2	700g×2	900g×2	1250g×2	900g×2	2200g×2	

Dielectric strength	Insulating stick (except for the antenna portion): Insulating stick - Surface		HP-S3, HP-U3, HP-S6, HP-U6, HP-S20, HP-U20	Interval of 30 cm, 75 kV, 5 min
	Detector: Contact tip - Joint part		HP-U3, HP-U6	20 kV, 5 min
	Contact tip - Grip		HP-U20	50 kV, 5 min
			HP-T3, HP-T6	14 kV, 5 min

# HP-22VR

Wireless Voltage Detector/Phase Tester  
with Phase Sequence

AC 20kV~42kV



### ■ Accessory



Bag for housing

### ■ Features

- With Phase sequence (phase rotation) checking function.  
(Universal joint type)

### [Attention]

Please designate the frequency of 50Hz or 60Hz.

### ■ Specifications

Working voltage range	20kV~42kV	
Frequency	50 Hz or 60 Hz	
Phase test function	Whether it is in phase or has a 120° difference is determined. 120° advance or delay is determined.	
Distance for phase test	Min. distance between transmission side and reception side: 5 m	
Insulation resistance	100 MΩ or larger between the contact tip (metal fitting) and joint	
Threshold voltage	AC 1,500V ± 20% (to ground)	
Operating temperature range	-10°C~+40°C	
Indication	Light	Visible in environment with brightness of 8000 lx
	Sound	50 dB or higher at a distance of 2 m
Structure of detection part	Prevents water from seeping into internal parts.	
Batteries used	A 9-V dry cell 6F22 (S-006P) in each	

\* The radio wave intensity conforms to the Japanese Radio Law.

Index etc.

Voltage detector

Auxiliary device for voltage detection

Voltage detector checker

Phase tester

Grounding hook

Discharge hook stick

Discharge stick

Measuring instrument

Illuminator

Railway products

Information materials



# Grounding hook

A wide variety of lineup according to the application

■ When ordering, please determine the followings.

1. Type of tip metal fitting
2. Type of insulating stick (supplementary connecting type, telescopic type)
3. Length and diameter of insulating stick
4. Cross-sectional area and length of earth wire
5. Type of grounding metal fitting
6. Working voltage

[Attention]

- Three-phase/one set (three-unit set) is the standard (except for railways).
- The bag for housing is sold separately (except for partial products).
- The products are manufactured to order, so there may be cases when they are non-returnable.

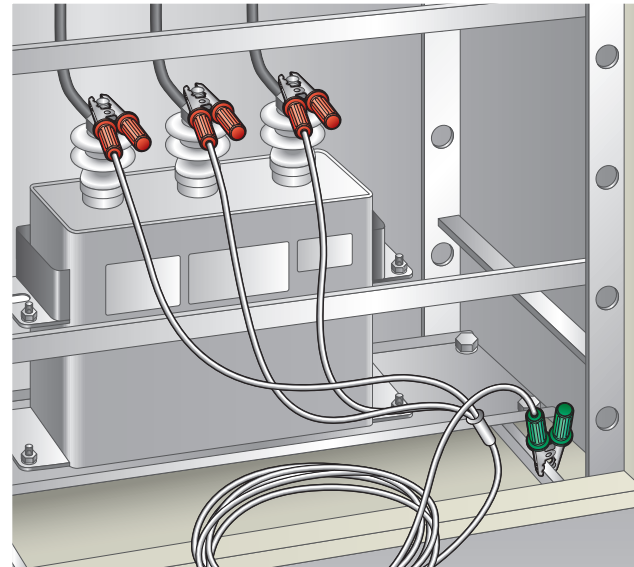

■ How to connect operating rod (As a standard, a rod of 3 m or less consists of a single rod.)

Figures inside ( ) indicate outside diameter of the rod.

Length of operating rod	Earth wire of 38 mm <sup>2</sup> or less is used.		In the case of using earth wire of 60 mm <sup>2</sup> or more
		In the case of using a strong type tip metal fitting	
3.5m (connection of 2 rods)	1.5m (31 φ) + 2.0m (34 φ)	1.5m (31 φ) + 2.0m (34 φ)	1.5m (31 φ) + 2.0m (34 φ)
4.0m (connection of 2 rods)	2.0m (31 φ) + 2.0m (34 φ)	2.0m (31 φ) + 2.0m (34 φ)	2.0m (31 φ) + 2.0m (34 φ)
4.5m (connection of 2 rods)	2.5m (31 φ) + 2.0m (34 φ)	2.5m (31 φ) + 2.0m (34 φ)	2.5m (34 φ) + 2.0m (39 φ)
5.0m (connection of 2 rods)	2.5m (31 φ) + 2.5m (34 φ)	2.5m (31 φ) + 2.5m (34 φ)	2.5m (34 φ) + 2.5m (39 φ)
6.0m (connection of 2 rods)	3.0m (34 φ) + 3.0m (39 φ)	3.0m (34 φ) + 3.0m (39 φ)	3.0m (34 φ) + 3.0m (39 φ)
6.0m (connection of 3 rods)	2m (34 φ) + 2m (39 φ) + 2m (39 φ)	2m (34 φ) + 2m (39 φ) + 2m (39 φ)	2m (34 φ) + 2m (39 φ) + 2m (39 φ)
Kind of joint	<span style="background-color: yellow;">    </span> uses an insulating joint, and others use a metallic joint.		

■ Type of grounding wire (transparent vinyl covered electric wire)

Cross-sectional area	8mm <sup>2</sup>	14mm <sup>2</sup>	22mm <sup>2</sup>	38mm <sup>2</sup>	60mm <sup>2</sup>	100mm <sup>2</sup>
Wire configuration	7/22/0.26	7/38/0.26	7/7/40/0.12	19/38/0.26	19/60/0.26	37/51/0.26
Weight	105g/m	180g/m	265g/m	455g/m	680g/m	1120g/m
Finished outside diameter	6.6mm	8.4mm	10.1mm	12.9mm	15.2mm	19.0mm

■ Grounding metal fitting

Grounding metal fitting (SA107-B,C,D)

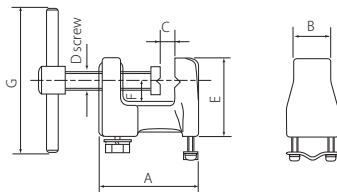

\* The photo shows SA107-C.

Valve type grounding handle (SA110)

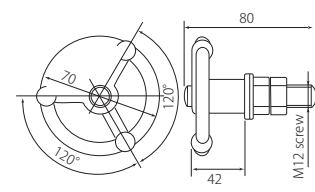

Model	Mounting method	Applicable wire	A	B	C	D	E	F	G	Weight	
SA107-B	Screw tightening method	8mm <sup>2</sup> ~ 14mm <sup>2</sup>	51	18	18	10	39	13	65	280g	
SA107-C	Screw tightening method	22mm <sup>2</sup> ~ 38mm <sup>2</sup>	66	24	27	12	53	14	95	570g	
SA107-D	Screw tightening method	60mm <sup>2</sup> ~ 100mm <sup>2</sup>	90	30	38	12	75	23	95	1080g	
SA110	Stud bolt type	M12 stud	Valve type grounding handle								320g

# Grounding hook component

Table 1

● When ordering the earth hook, please determine the following.

1. Type of tip metal fitting
2. Type of insulating stick (supplementary connecting type, telescopic type)
3. Length and diameter of insulating stick
4. Cross-sectional area and length of earth wire
5. Type of grounding metal fitting
6. Working voltage

**Attention**

- Three-phase/one set is a standard. (Used with AC)
- The bag for housing is sold separately.
- The products are manufactured to order, so there may be cases when they are non-returnable. Please note this when placing an order.

■ Fixed type tip metal fitting (The operating rod and tip metal fitting are fixed.)

External appearance	Model name	Range of use (mm)	Dimensions	Weight	Remarks
	MA121-A Large size	φ8 to 40		710g	For round bus bar
	MA121-AS Special large size	φ30 to 80		800g	For round bus bar
	MA121-AG Strong large size	φ20 to 52, L=195 φ40 to 80, L=195 φ70 to 150, L=225 φ100 to 180, L=225		1200g 1920g	For round bus bar (Earth wire: 60 mm <sup>2</sup> or more)
	MA121-C Slanted large size	φ8 to 40		930g	For round bus bar
	MA111-A Universal type	φ8 to 40 Thickness of bus bar within 12 Width within 75		930g	For dual use of round and flat bus bars
	MA111-AG Strong universal type	φ20 to 52 Thickness of bus bar within 20 Width within 100		1600g	For dual use of round and flat bus bars (Earth wire: 60 mm <sup>2</sup> or more)
	MA111-C Slanted universal type	φ8 to 40 Thickness of bus bar within 12 Width within 75		1060g	For dual use of round and flat bus bars
	MA122-A Medium size	φ5 to 25		370g	For round bus bar
	MA114-A Horizontal & slanted copper band type	Thickness within 25 Width within 100		1000g	For flat bus bar
	MA114-AG Strong horizontal & slanted copper band type	Thickness within 30 Width within 100		2250g	For flat bus bar (Earth wire: 60 mm <sup>2</sup> or more)
	MA115-A Cubicle type	φ5 to 25 Thickness of bus bar within 30 Width no limit		500g	For dual use of round and flat bus bars
	MA115-AG Strong cubicle type	φ8 to 25 Thickness of bus bar within 35 Width no limit		1050g	For dual use of round and flat bus bars (Earth wire: 60 mm <sup>2</sup> or more)
	MA115-AN Cubicle type for narrow spaces	φ5 to 25 Thickness of bus bar within 30 Width within 50		480g	For dual use of round and flat bus bars
	MA115-AH Cubicle type with claw	φ5 to 25 Thickness of bus bar within 30 Width within 50		530g	For dual use of round and flat bus bars

Index etc.
Voltage detector
Auxiliary device for voltage detection
Voltage detector checker
Phase tester
<b>Grounding hook</b>
Discharge hook stick
Discharge stick
Measuring instrument
Illuminator
Railway products
Information materials

# Grounding hook component

Table 2

- When ordering the earth hook, please determine the following.
- 1.Type of tip metal fitting
  - 2.Type of insulating stick (supplementary connecting type, telescopic type)
  - 3.Length and diameter of insulating stick
  - 4.Cross-sectional area and length of earth wire
  - 5.Type of grounding metal fitting
  - 6.Working voltage

**Attention**

- Three-phase/one set is a standard. (Used with AC)
- The bag for housing is sold separately.
- The products are manufactured to order, so there may be cases when they are non-returnable. Please note this when placing an order.

■ Detachable type tip metal fitting (The operating rod and tip metal fitting are detachable.)

External appearance	Model name	Range of use (mm)	Dimensions	Weight	Remarks
	<b>MA121-B</b> Large size	φ8 to 40		760g	For round bus bar Closed stocks (set items) of the type ZB, type YB have a groove width of 5.5 mm.
	<b>MA121-BS</b> Special large size	φ30 to 80		860g	For round bus bar
	<b>MA121-BG</b> Strong large size	φ20 to 52, L=200 φ40 to 80, L=200 φ70 to 150, L=200 φ100 to 180, L=230		1250g 1950g	For round bus bar (Earth wire: 60 mm <sup>2</sup> or more)
	<b>MA121-D</b> Large slanted type	φ8 to 40		930g	For round bus bar
	<b>MA111-B</b> Universal type	φ8 to 40 Thickness of bus bar within 12 Width within 75		980g	For dual use of round and flat bus bars
	<b>MA111-BG</b> Strong universal type	φ20 to 52 Thickness of bus bar within 20 Width within 100		1680g	For dual use of round and flat bus bars (Earth wire: 60 mm <sup>2</sup> or more)
	<b>MA111-D</b> Universal slanted type	φ8 to 40 Thickness of bus bar within 12 Width within 75		930g	For dual use of round and flat bus bars
	<b>MA122-B</b> Medium size	φ5 to 25		420g	For round bus bar
	<b>MA114-B</b> Horizontal & slanted copper band type	Thickness within 25 Width within 100		1010g	For flat bus bar
	<b>MA115-B</b> Cubicle type	φ5 to 25 Thickness of bus bar within 30 Width no limit		520g	For dual use of round and flat bus bars
	<b>MA105</b> Tip metal fitting for operating rod			170g	To be used for all detachable models of the types MA115-B, ZB, and YB, except for closed stocks
	<b>MA105-S</b> Tip metal fitting for operating rod			70g	To be used for closed stocks of the types MA115-B, ZB, and YB

# Fixed type

● When ordering the earth hook, please determine the following.

1. Type of tip metal fitting
2. Type of insulating stick (supplementary connecting type, telescopic type)
3. Length and diameter of insulating stick
4. Cross-sectional area and length of earth wire
5. Type of grounding metal fitting
6. Working voltage

### Attention

- Three-phase/one set is a standard. (Used with AC)
- The bag for housing is sold separately.
- The products are manufactured to order, so there may be cases when they are non-returnable. Please note this when placing an order.

(Closed stock) = (Operating rod with tip metal fitting + Grounding wire + Grounding metal fitting) × 3

(The bag for housing is sold separately.)

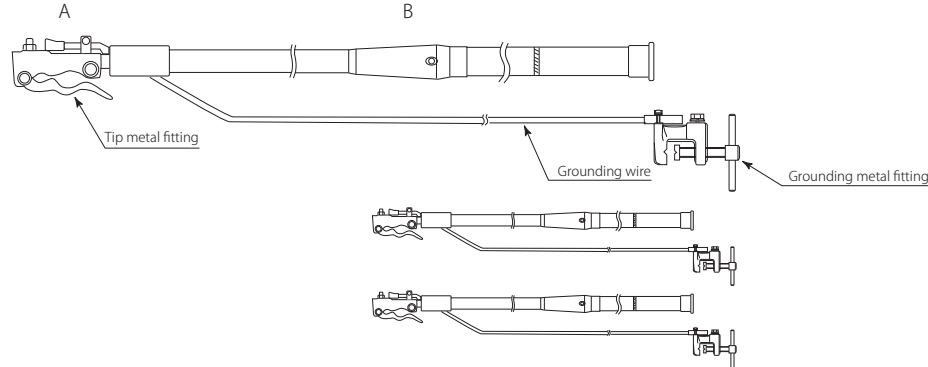

A Model of tip metal fitting	B Class	Breakdown of class			Grounding wire	Grounding metal fitting	Applicable voltage
		Length, kind of operating rod					
Large fixed type MA121-A (MA121-C)	Type 5	Neo pipe	0.5m	Single rod	22mm <sup>2</sup> ×3m	SA107C	6.6kV
	Type 10	"	1.0m	"	"	"	"
	Type 15	"	1.5m	"	22mm <sup>2</sup> ×4m	"	22kV
	Type 20	"	2.0m	"	"	"	"
	Type 25	"	2.5m	"	22mm <sup>2</sup> ×5m	"	77kV
	Type 30	"	3.0m	"	"	"	"
	Type 35	"	3.5m (1.5+2)	Connecting type	22mm <sup>2</sup> ×6m	"	"
	Type 40	"	4.0m (2+2)	"	"	"	154kV
	Type 45	"	4.5m (2.5+2)	"	22mm <sup>2</sup> ×7m	"	"
	Type 50	"	5.0m (2.5+2.5)	"	"	"	"
Universal fixed type MA111-A (MA111-C)	Type 60	"	6.0m (3+3)	"	"	"	275kV
	Type 60	"	6.0m (2×3)	"	"	"	"
Medium-sized fixed type MA122-A	Type 5	"	0.5m	Single rod	14mm <sup>2</sup> ×3m	SA107B	6.6kV
Fixed type for cubicle MA115-A	Type 10	"	1.0m	"	"	"	"
	Type 15	"	1.5m	"	14mm <sup>2</sup> ×4m	"	22kV
	Type 20	"	2.0m	"	"	"	"

(Regarding the Type 60 described above, please determine either connection with two rods or three rods.)

# Detachable type

(Closed stock) = (Detachable tip metal fitting + Grounding wire + Grounding metal fitting) × 3 + (Detachable operating rod) × 1 (The bag for housing is sold separately.)

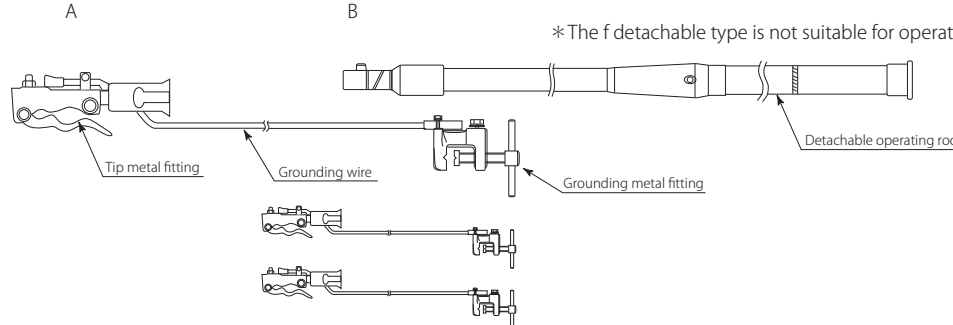

\*The f detachable type is not suitable for operation at 4 m or more.

A Model of tip metal fitting	B Class	Breakdown of class			Grounding wire	Grounding metal fitting	Applicable voltage	
		Length, kind of operating rod						
Large detachable type MA121-B (MA121-D)	Type 5	Neo pipe	0.5m	Single rod	22mm <sup>2</sup> ×3m	SA107C	6.6kV	
	Type 10	"	1.0m	"	"	"	"	
	Type 15	"	1.5m	"	22mm <sup>2</sup> ×4m	"	22kV	
	Type 20	"	2.0m	"	"	"	"	
	Type 25	"	2.5m	"	22mm <sup>2</sup> ×5m	"	77kV	
	Type 30	"	3.0m	"	"	"	"	
	Type 35	"	3.5m (1.5+2)	Connecting type	22mm <sup>2</sup> ×6m	"	"	
	Type 40	"	4.0m (2+2)	"	"	"	154kV	
	Universal detachable type MA111-B (MA111-D)	Type 5	"	0.5m	Single rod	14mm <sup>2</sup> ×3m	SA107B	6.6kV
		Type 10	"	1.0m	"	"	"	"

Index etc.

Voltage detector

Auxiliary device for voltage detection

Voltage detector checker

Phase tester

Grounding hook

Discone hook stick

Discharge stick

Measuring instrument

Illuminator

Railway products

Information materials

Operating rod of compressed tightening-type telescopic model for power transmission line

# Type Z

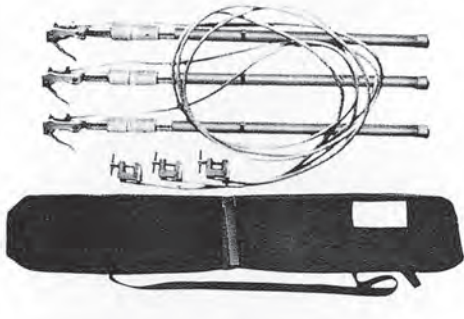

(Closed stock) = (Operating rod with tip metal fitting + Grounding wire + Grounding metal fitting) × 3 + (Bag for housing) × 1 or × 3

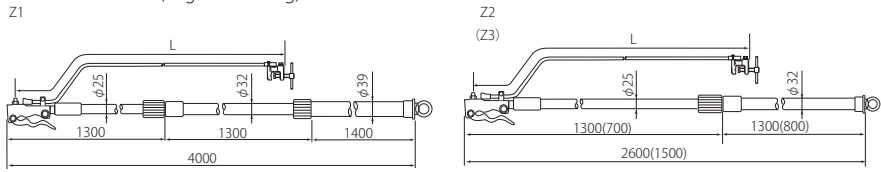

### ■ Grounding metal fitting SA107-C Insulating stick: Epoxy pipe

Type	Applicable voltage	Tip metal fitting	Grounding wire	Length at extended state	At storage	No. of connections	Bag for housing	Weight of contents & bag
Z1	275kV	MA121-A	22mm <sup>2</sup> × 5m	4.0m	1.8m	3	Capacity of 1 phase portion	15.5kg
Z2	154kV	"	22mm <sup>2</sup> × 4m	2.6m	1.5m	2	Capacity of 3-phase portion	11.0kg
Z3	77kV	"	22mm <sup>2</sup> × 3m	1.5m	1.1m	2	"	8.8kg

Operating rod of compressed tightening-type telescopic model for power transmission line

# Type ZB



(Closed stock) = (Detachable tip metal fitting + Grounding wire + Grounding metal fitting) × 3 + (Operating rod) × 1 + (Bag for housing) × 1

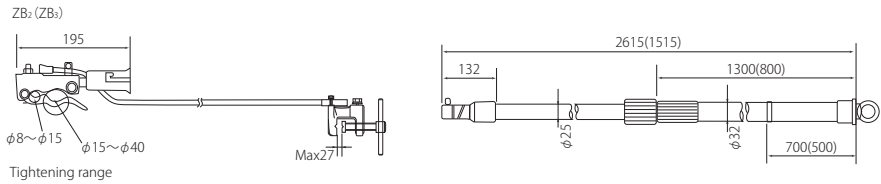

### ■ Grounding metal fitting SA107-C Insulating stick: Epoxy pipe

Type	Applicable voltage	Tip metal fitting	Grounding wire	Length at extended state	At storage	No. of connections	Bag for housing	Weight of contents & bag
ZB2	154kV	MA121-B (Groove: 5.5 mm)	22mm <sup>2</sup> × 4m	2.6m	1.4m	2	Capacity of 3-phase portion for 1800 × 1200	9.3kg
ZB3	77kV	"	22mm <sup>2</sup> × 3m	1.5m	0.9m	2	Capacity of 3-phase portion for 1200 × 1200	7.8kg

Operating rod of button type telescopic model

# Type Y

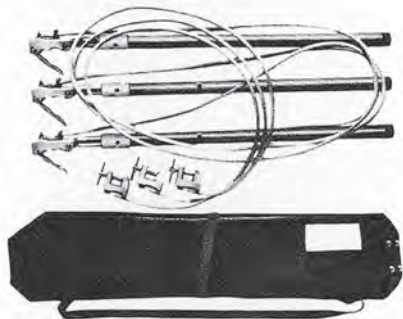

(Closed stock) = (Operating rod with tip metal fitting + Grounding wire + Grounding metal fitting) × 3 + (Bag for housing) × 1

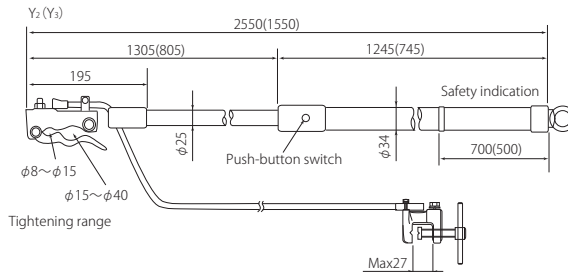

### ■ Grounding metal fitting SA107-C Insulating stick: Neo pipe

Type	Applicable voltage	Tip metal fitting	Grounding wire	Length at extended state	At storage	No. of connections	Bag for housing	Weight of contents & bag
Y2	154kV	MA121-A	22mm <sup>2</sup> × 4m	2.5m	1.4m	2	Capacity of 3-phase portion	11.5kg
Y3	77kV	"	22mm <sup>2</sup> × 3m	1.5m	0.9m	2	"	9.0kg

Operating rod of button type telescopic model

# Type YB

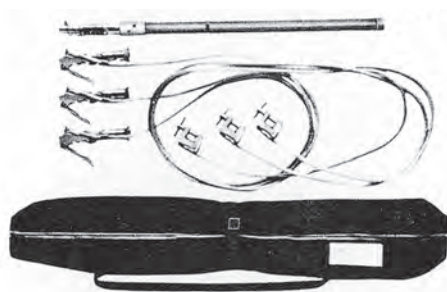

(Closed stock) = (Detachable tip metal fitting + Grounding wire + Grounding metal fitting) × 3 + (Operating rod) × 1 + (Bag for housing) × 1

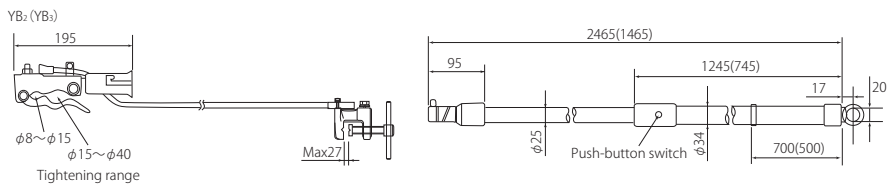

### ■ Grounding metal fitting SA107-C Insulating stick: Neo pipe

Type	Applicable voltage	Tip metal fitting	Grounding wire	Length at extended state	At storage	No. of connections	Bag for housing	Weight of contents & bag
YB2	154kV	MA121-B	22mm <sup>2</sup> × 4m	2.4m	1.4m	2	Capacity of 3-phase portion	9.6kg
YB3	77kV	"	22mm <sup>2</sup> × 3m	1.4m	0.9m	2	"	8.1kg

# Type H

Universal type for cubicle

With Bag for housing

### ■Features

- The clip is L-shaped
- It's easily install and hard to detach.
- Soft and clear coated grounding wire.

### ■Dimensions

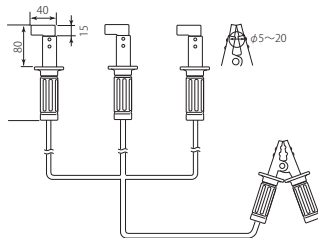

## Standard model for Cubicle and high voltage receiving equipment.



### ■Accessory



Bag for housing

### ■Specifications

Type	Tip metal fitting	Length of insulating stick	Grounding wire	Grounding metal fitting	Hammer-in type grounding bar	Bag for housing	Weight
H	Insulation rubber clip	With rubber grip	22mm <sup>2</sup> ×1.2m×3 wires 8mm <sup>2</sup> ×5 m×1 wire	Clip	None	Portable type 300×360×110	3.5kg

# Type HA

Universal type for cubicle

With Bag for housing

Check the QR code for details.



### ■Dimensions

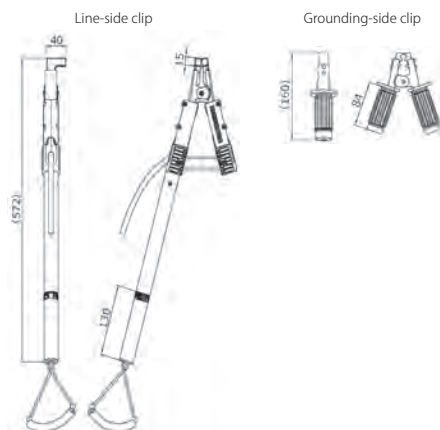

## Improved model from type H.



When you pull the rope, clip is opened.



When you push the rope, clip is closed.



### ■Accessory



Bag for housing

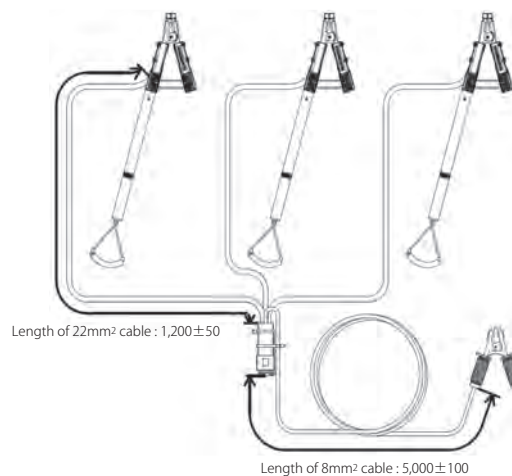

### ■Specifications

Type	Tip metal fitting	Length of insulating stick	Grounding wire	Grounding metal fitting	Hammer-in type grounding bar	Bag for housing	Weight
HA	Insulation rubber clip	572mm	22mm <sup>2</sup> ×1.2m×3 wires 8mm <sup>2</sup> ×5 m×1 wire	Clip	None	Portable type 400×600×100	4.5kg

Index etc.

Voltage detector

Auxiliary device for voltage detection

Voltage detector checker

Phase tester

Grounding hook

Discone hook stick

Discharge stick

Measuring instrument

Illuminator

Railway products

Information materials

Index etc.
Voltage detector
Auxiliary device for voltage detection
Voltage detector checker
Phase tester
Grounding hook
Discone hook stick
Discharge stick
Measuring instrument
Illuminator
Railway products
Information materials

# Type C

Universal type for cubicle

For 6.6 kV (narrow space type) with carrying case



### ■Dimensions

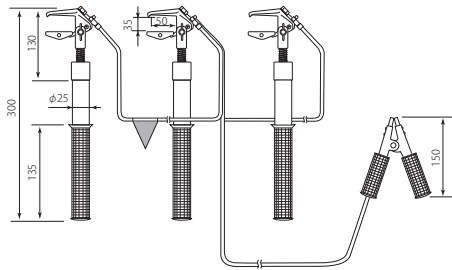

### ■Accessory



Bag for housing

# Type F

Universal type for cubicle

For 6.6 to 22 kV with carrying case

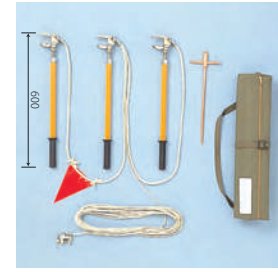

### ■Dimensions

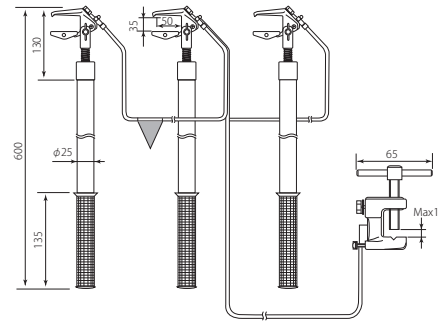

### ■Accessory

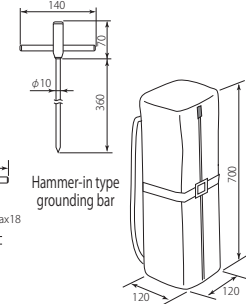

Hammer-in type grounding bar

Bag for housing

# Type S

For round bus bar

For 6.6 to 22 kV with carrying case

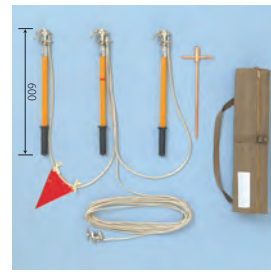

### ■Dimensions

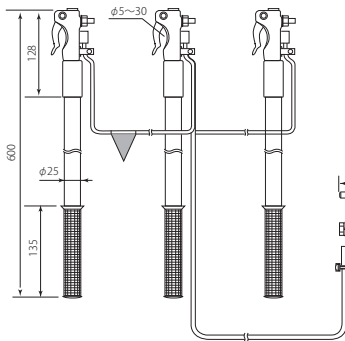

### ■Accessory

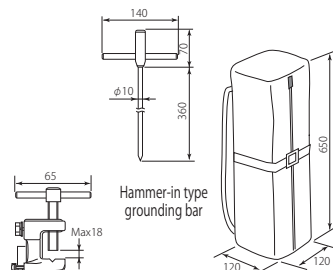

Hammer-in type grounding bar

Bag for housing

### ■Specifications

Type	Tip metal fitting	Length of insulating stick	Grounding wire	Grounding metal fitting	Hammer-in type grounding bar	Bag for housing	Weight
C	MA115-AN	Neo pipe (φ25×35mm) with rubber grip	14mm <sup>2</sup> ×0.7m×2 wires (with red triangular flag) 8mm <sup>2</sup> ×7m×1 wire	Clip	None	Portable type 300×360×110	3.4kg
F	MA115-AH	Neo pipe (φ25×335mm) with rubber grip	22mm <sup>2</sup> ×1.5m×2 wires (with red triangular flag) 8mm <sup>2</sup> ×15m×1 wire	SA107-B	φ10 steel bar	Portable type 700×120 <sup>□</sup>	5.6kg
S	MA122-A	Neo pipe (φ25×337mm) with rubber grip	22mm <sup>2</sup> ×1.5m×2 wires (with red triangular flag) 8mm <sup>2</sup> ×15m×1 wire	SA107-B	φ10 steel bar	Portable type 650×120 <sup>□</sup>	5.0kg

Type H is made by Hasegawa Electric Co., Ltd., and all other types are made by Sunasaki Seisakusho.

# HSH-K6

Discone hook stick with voltage detector

AC 6.6kV

## Enhance Work Safety and Efficiency



### ■Features

- Work safety and efficiency are improved by combining the voltage-detecting function to the medium voltage cutout operating rod.

### ■Specifications

Model	HSH-K6	
Working voltage range	AC 6.6kV	
Operation starting voltage (Voltage to ground)	1300V±20% (continuous indications of sound & light) (with insulated wire)	
Insulation resistance	Between contact tip (metal fitting) and grip: 100 MΩ or more	
Dielectric strength	Ditto: 1 min	
Leakage current	1 mA or less at dielectric strength test	
Indication of operation	Light	Light emission: It shall be able to confirm luminance of 8,000 lux.
	Sound	Sound: 50 dB or more at a distance of 2 m

Operating temperature range	-10°C~+40°C
Structure	Waterproof (Water shall not ingress.)
Tensile performance	200kg, 1 min
Battery	6R61 or 6F22(9V) × 1 pcs
Dimensions	About 470mm
Weight	About 390g

\* Without the casing

# SA109 □ - □

Hook Stick for D/S (Disconnecting Switch)

AC 10kV~110kV

### ■Features

- There are lineups with or without the water drip shed (for outdoor use) as well as chain.

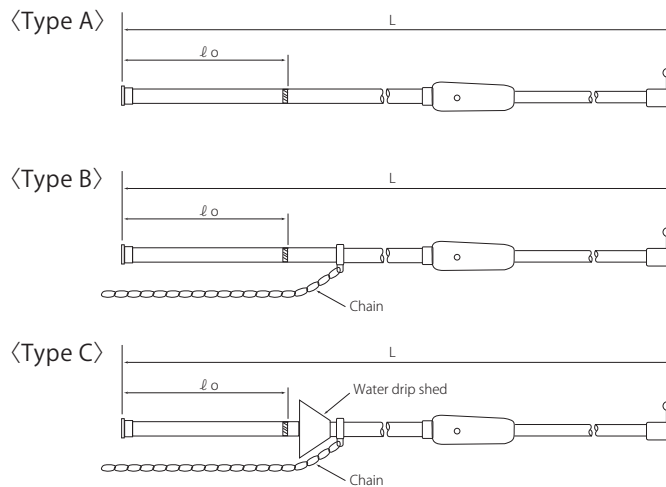

### ■Specifications

Model (SA109)	Indoor	A-1	A-1.5	A-2	A-3	A2-4	A2-5	A2-6	A3-6	Chain	Water drip shed		
	Outdoors	B-1	B-1.5	B-2	B-3	B2-4	B2-5	B2-6	B3-6				
Applicable voltage		10kV	20kV	30kV	40kV	70kV		110kV		Type A	Indoor	None	None
Length of hook rod(L)		1.0m	1.5m	2.0m	3.0m	4.0m (connection of 2 rods)	5.0m (connection of 2 rods)	6.0m (connection of 2 rods)	6.0m (connection of 3 rods)	Type B	//	Exist	None
Rod dia. & connecting method	φ 31	1.0m	1.5m	2.0m	3.0m	2.0m	2.5m	—	—	Type C	Outdoors	Exist	Exist
	φ 34	—	—	—	—	2.0m	2.5m	3.0m	2.0m				
	φ 39	—	—	—	—	—	—	3.0m	2.0m+2.0m				
Length of grip (l o)		0.3m	0.5m	0.5m	0.7m	0.7m	1.0m	1.0m	1.0m				
Tip metal fitting for discone hook rod		SA108-B			SA108-C		SA108-E						

# D □

Hook stick for D/S in Cubicle

AC 6.6kV~30kV

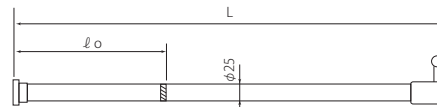

### ■Specifications

Class	D1	D2	D3	D4
Length (L)	0.5m	1.0m	1.5m	2.0m
Length of grip (l o)	0.3m	0.3m	0.5m	0.5m
Applicable voltage	6.6kV	10kV	20kV	30kV

Index etc.

Voltage detector

Auxiliary device for voltage detection

Voltage detector checker

Phase tester

Grounding hook

Discone hook stick

Discharge stick

Measuring instrument

Illuminator

Railway products

Information materials



Index etc.
Voltage detector
Auxiliary device for voltage detection
Voltage detector checker
Phase tester
Grounding hook
Discon hook stick
<b>Discharge stick</b>
Measuring instrument
Illuminator
Railway products
Information materials

# HRD-27S Residual electric charge discharging stick

- Voltage detection functions
- Built-in resistance

**DC 27kV** (Maximum discharge voltage)

Emits sound and light

### ■ Features

- Allows for residual electric charge to be discharged safely and easily
- When discharging, allows for visual and auditory confirmation of discharge status through an audio and light emitting display at the center of the detector
- The metal fitting can be switched according to application (2 types)

This device is not a voltage detector. Use a voltage detector on the circuit to confirm that the power is not running before using this device.

### ■ Detector



### ■ Accessory



### ■ Dimensions

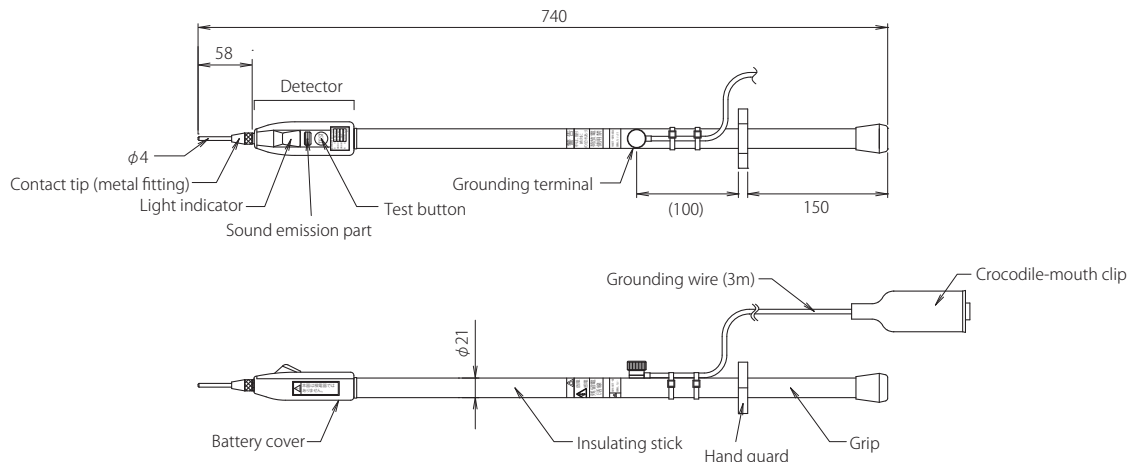

### ■ Specifications

Discharge voltage	DC27kV (Max)
Discharge capacity	1 μF (Max)
Discharge time	5 seconds or less (DC27 kV, 50 V or less at 1 μF)
Discharge resistance	600kΩ
Operation stop voltage	DC40V ±20%
Indication (Light/sound)	Light: It shall be able to confirm in the luminance of 8,000 lux Sound: 50 dB or more at a distance of 2 m
Battery	LR44 alkaline button cell (1.5 V) x2 pcs.
Battery life	Approx. 4 hours of continuous operation
Operating temperature range	-10°C ~ +40°C
Weight	About 800 g
Accessories	Bag for housing , contact tip (hook metal fitting), each 1 pc.

## Uses sound and light to visualize the complete discharge of accumulated charge



# HRD-27 Residual electric charge discharging stick

• Built-in resistance

**DC 27kV**(Maximum discharge voltage)

## Built-in resistance type



### ■Features

- Allows for residual electric charge to be discharged safely and easily
- The metal fitting can be switched according to application (2 types)

### ■Dimensions

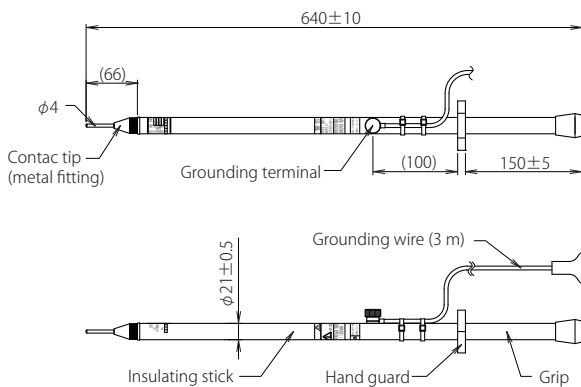

### ■Accessory



Straight metal fitting

Hook metal fitting



Bag for housing (DA16003)

### ■Specifications

Discharge voltage	DC27kV (Max)
Discharge capacity	1 μF (Max)
Discharge time	5 seconds or less (DC27 kV, 50 V or less at 1 μF)
Discharge resistance	600kΩ
Operating temperature range	-10°C ~ +40°C
Weight	About 660 g
Accessory	Bag for housing , contact tip (hook metal fitting) , each 1 pc.

# Order-made residual electric charge discharging stick

• No built-in resistance

\*Select from the following specifications

**AC 6.6kV**

## Simple Discharge stick with no built-in Internal Resistance

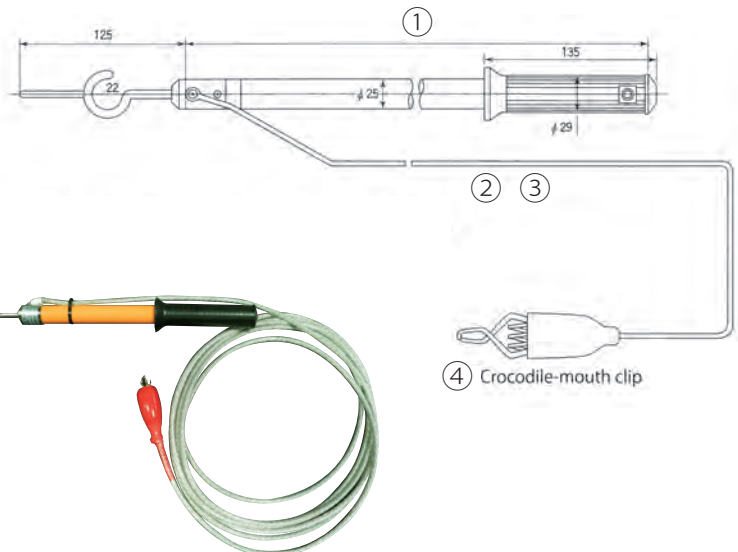

• This product is custom built according to the following selected specifications ((1) to (4))

(1)Length of insulation stick	<input type="checkbox"/> 0.5m <input type="checkbox"/> 1.0m <input type="checkbox"/> 1.5m <input type="checkbox"/> 2.0m
(2)Cross-sectional area of grounding wire	<input type="checkbox"/> 8mm <sup>2</sup> <input type="checkbox"/> 14mm <sup>2</sup>
(3)Length of grounding wire	<input type="checkbox"/> 2m <input type="checkbox"/> 3m <input type="checkbox"/> 4m <input type="checkbox"/> 5m <input type="checkbox"/> 6m <input type="checkbox"/> 7m <input type="checkbox"/> 8m <input type="checkbox"/> 9m <input type="checkbox"/> 10m
(4)Grounding metal fitting type	*For the Dimensions, refer to P32. <input type="checkbox"/> Crocodile-mouth clip <input type="checkbox"/> Vise type (SA107-B)

Index etc.

Voltage detector

Auxiliary device for  
voltage detection

Voltage detector  
checker

Phase tester

Grounding hook

Discone hook stick

Discharge stick

Measuring  
instrument

Illuminator

Railway products

Information materials

# VOLTECT

## Extra-High Voltage Detecting System

AC 3.3kV~550kV

This indication and warning apparatus detects the presence or absence of a charged state of special high voltage substations, electric power transmission lines, power receiving equipment, etc. in a non-contact operation.

\* This apparatus is produced and sold by our company, having inherited technologies of former Million Electric Mfg. Co. Ltd.

### ■ Features

- Economical as it can be simply installed without using PT, PD.
- Easy installation and maintenance.

### Protector

- HG7-P1B (for single phase)
- HG7-P2B (for two-phase)



### Controller

- HG7-SM○○
  - HG7-DM○○
- \* Refer to the following Rating table.

### Voltage Meter

- DVF-11M

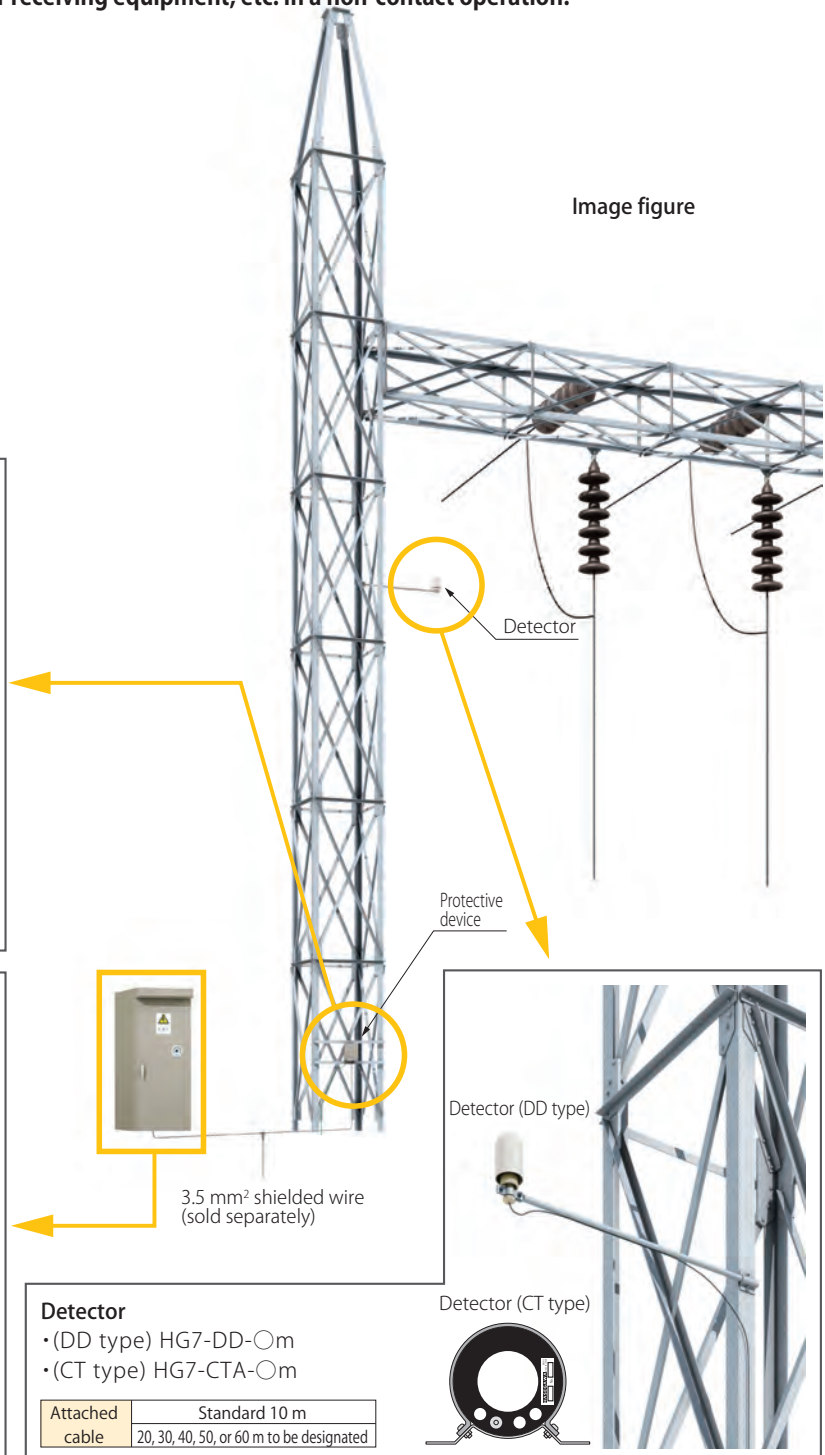

### Detector

- (DD type) HG7-DD-○m
- (CT type) HG7-CTA-○m

Attached cable	Standard 10 m
	20, 30, 40, 50, or 60 m to be designated

### ■ Rating table

Indicating type of the measuring instrument	Voltage switching indication			Indication proportional to voltage
	Single-phase detection	SM1AH(high sensitivity)	SM1A(standard sensitivity)	
Type of Controller (*1)	Two-phase detection	SM2AH(high sensitivity)	SM2A(standard sensitivity)	DM2A
Line voltage (50/60 Hz)	3.3~550 kV			
Contact	Operating time at charging/power failure	0.5 sec or less (However, ratio of operating point setting: 70 % or less)		
	Configuration	1c (for single phase), 1c × 2 (for two-phase)		
	Switching capacity/100 VDC	Resistance load: 0.5 A, Induction load: 0.1 A		
	Max. allowable circuit voltage	180V. DC, 140V. AC		
Meter	Output	0~1mA. DC		
	Internal resistance	Less than 5 kΩ	About 1.5kΩ	
Operation indication lamp	Charging: Red light, Power failure: Green light, No power: Extinguished (milky white)			
Power supply voltage	Standard: 110 V, DC (Others: 24 V, 220 V)			
Power supply current	75 mA (for single phase), 100 mA (for two-phase)			
Withstand voltage, insulation resistance (*2)	2 kV, AC-1 min; 10 MΩ or more/500 V, DC			
Impulse withstand voltage	±7 kV, 1.2 × 50 μS (between terminals in a lump ~ terminal E & case)			

- \* 1. DM1A & DM2A in the table are of standard sensitivity. In addition to these, there is the low-sensitivity type SM (L).  
 \* 2. Between terminals in a group and case. However, terminal E could be included in the terminal group or excluded during the test.

### ■ How to decide the specification

Installation site of detector	Outdoors		Indoor		Inside the cubicle	
	Control equipment	Detector	Control equipment	Detector	Control equipment	Detector
Nominal line voltage						
3.3kV	—	—	H	CT	H	CT
6.6kV	H	—	H, ST	CT	H, ST	CT
11kV			H			
22kV	H, ST	—	H, ST	DD	H	DD
33kV			ST			
40~160kV	ST	—	ST	DD	ST	—
161kV~550kV			Low sensitivity (L)			

\* As for H, use high sensitivity (H) of the type SM.

\* As for ST, use standard sensitivity of type SM or type DM.

# VOLTECT SPECIFICATION TABLE

## VOLTECT SPECIFICATION TABLE

Note: When your receipt of client order or when your offering quotation to the client, please write its q'ty and check  in for your confirmation.

Date:

Order: <input type="checkbox"/>	Quotation: <input type="checkbox"/>	Delivery date:
Customer' name and address:		Delivery place:
Tel/Fax:		Tel/Fax:
The person in charge(Name & Sec.)		Installation place name & address:
Tel/Fax:		

Normal line voltage _____ kV	Detector insalltion place:	Outdoor <input type="checkbox"/>	Indoor <input type="checkbox"/>
		In board <input type="checkbox"/>	
		Internal GIS sensor equipped <input type="checkbox"/>	

※Check instruction manual P.12 (Notice for Interval Distance Table), and please select the sensitivity of the controller.

In case changing a installed Voltect,please write its controller' manufacturing number and so on for avoiding its mis-specification and for its confirmation:	
Installed controller type:HG7- M A	Manufacturing No.
Q'ty set	Made by: date and year

Controller;	Type	Controller Sensitivity	Q'ty	Operation power	Color	Special specification
Single	HG7-SM1A	Standard	set	(Standard) 110V.DC <input type="checkbox"/>	(Standard) 5Y7/1(Glossy) <input type="checkbox"/>	English name plate <input type="checkbox"/> Convertor inaide <input type="checkbox"/>
	HG7-SM1AH	High	set	(75~143V)	(Non standard)	
	HG7-SM1AL	Low	set	(Non standard) 24V.DC <input type="checkbox"/>	7.5BG6/1.5(Glossy) <input type="checkbox"/>	Others: <input type="checkbox"/>
	HG7-DM1A	Standard	set	(21~32V) Below,built-in converter	N7(Glossy) <input type="checkbox"/>	
Two phase	HG7-SM2A	Standard	set	110V.DC <input type="checkbox"/>		
	HG7-SM2AH	High	set	(90~170V)		
	HG7-SM2AL	Low	set	220V.DC <input type="checkbox"/>		
	HG7-DM2A	Standard	set	(110~250V) 110V.AC <input type="checkbox"/>		
				(85V~132V)		

Protector;	Type	Q'ty	Color	Special specification
Single	HG7-P1B	set	(Standard)5Y7/1(Glossy) <input type="checkbox"/> (Non standard) N7(Glossy) <input type="checkbox"/>	English name plate <input type="checkbox"/> Others: <input type="checkbox"/>
Two phase	HG7-P2B	set	7.5BG6/1.5 (Semi Glossy) <input type="checkbox"/> Others: <input type="checkbox"/>	

Detector;	Type	Q'ty	Lenghts of shield cable	Color(Only for DD Type)	
	HG7-DD-	m	set	Write in Type'lined m. (Standard) 10m	(Standard)N7(Glossy) <input type="checkbox"/> (Non standard) 5Y7/1 (Glossy) <input type="checkbox"/>
	HG7-CTA-	m	set	Example :HG7-DD-10m	Others <input type="checkbox"/>

Wide range AC Voltmeter	Type	Scale	Q'ty	Cover color
	DVF-11M	It's different depending on the line voltage, so please refer to a wide angle meter specification (VHG07-S-001).	set	(Standard) N1.5 <input type="checkbox"/> (Non standard)7.5BG4/1.5 <input type="checkbox"/>

Shield Cable	Type	Conductor'ssection area	Conductor'inner core	Length	Piece
	CVV-SB	3.5mm2	1c	m	pc.

Index etc.

Voltage detector

Auxiliary device for voltage detection

Voltage detector checker

Phase tester

Grounding hook

Discone hook stick

Discharge stick

Measuring instrument

Illuminator

Railway products

Information materials

# EWL-4

LED working light  
Ecopika-kun

EWL-4-M set (Model of the set)  
Contents: EWL-4 (Illuminator),  
EWL-2B (Battery unit)  
NN11024 (AC adapter)



## Robust, Professional Specification



### ■ Features

- The working light has 2 modes; lighting mode and flickering mode.
- The spotlight enables visual recognition at a distance of 10 m.
- With the built-in magnet in the hand guard, the irradiation angle can be easily adjusted.
- Shoulder belt and S-shaped hook.

### ■ Specifications

Illuminator EWL-4

Light source	Working light : LED × 42 pcs (equivalent to 12 W) Spot light : 5 W LED × 1 pc
Illuminance	Working light : 1,500 lux or more/30 cm Working light (dimmed state) : 500 lux or more/30 cm Spot light : 50,000 lux or more/30 cm (With fully charged battery unit (EWL-2B) in every case)
Continuous lighting time	Working light : Lighting About 5 hr. Lighting (dimmed state) About 15 hr. Flashing About 20 hr. (Cycle of flashing: About 6 Hz) Spotlight : About 5 hr. (With fully charged battery unit (EWL-2B) in every case)
Power supply	Battery unit (EWL-2B)
Structure	Waterproof structure (Protection code: Equivalent to IP44)
Specified temperature range	-10°C~40°C
Outside dimensions	φ 60mm × 275mm (except for hand guard)
Weight	About 480g (including battery unit)
Accessory	Shoulder belt, S-shaped hook

Battery unit EWL-2B

Battery to be used	Rechargeable type Nickel metal hydride packed battery (7.2 V, 2,200 mAh)
Charging system	About 4.5 hr. (using EWL-2C)
Battery life	Number of charges/discharges: 500 times or more (Differs depending on service conditions.)
Outside dimensions	25mm × 38mm × 236mm
Weight	About 245g

AC adapter NN11024

Input	AC100V~240V (50/60Hz)
Cable length	About 1.8m
Outside dimensions	46mm × 33mm × 24mm
Weight	About 70g

### ■ Option

EWL-2B



**Battery unit**  
It is installed in the main body

NN11024



**AC adapter**  
To charge the battery unit.

EWL-3D



**Charging stand**  
Holding unit for battery charging to hold the main body upright position. (EWL-2C is required.)

EWL-2C-B



**Cigar lighter socket adapter**  
It is possible to charge from a cigar lighter socket of a car. (Exclusive use for 12 VDC)

EWL-3R



**Red cover**  
RED color filter cover to use the work light as a warning lamp.



■ Visual recognition at a distance of 10 m is possible.

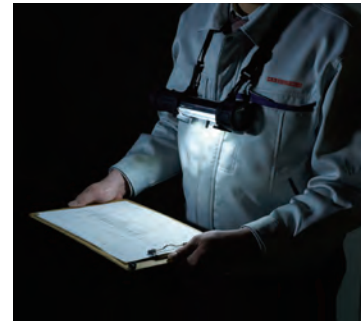

■ Work/operation at hand and foot is easy with shoulder belt.



■ Irradiation angle can be freely adjusted with the movable type magnet.

In the configuration of initial purchase, three items comprising EWL-4 (illuminator), EWL-2B (battery), and NN11024 (AC adapter) are required. Please order the closed stock (set item) which is economical.

Model of the set: EWL-three sets (EWL-4 + EWL-2B + NN11024)

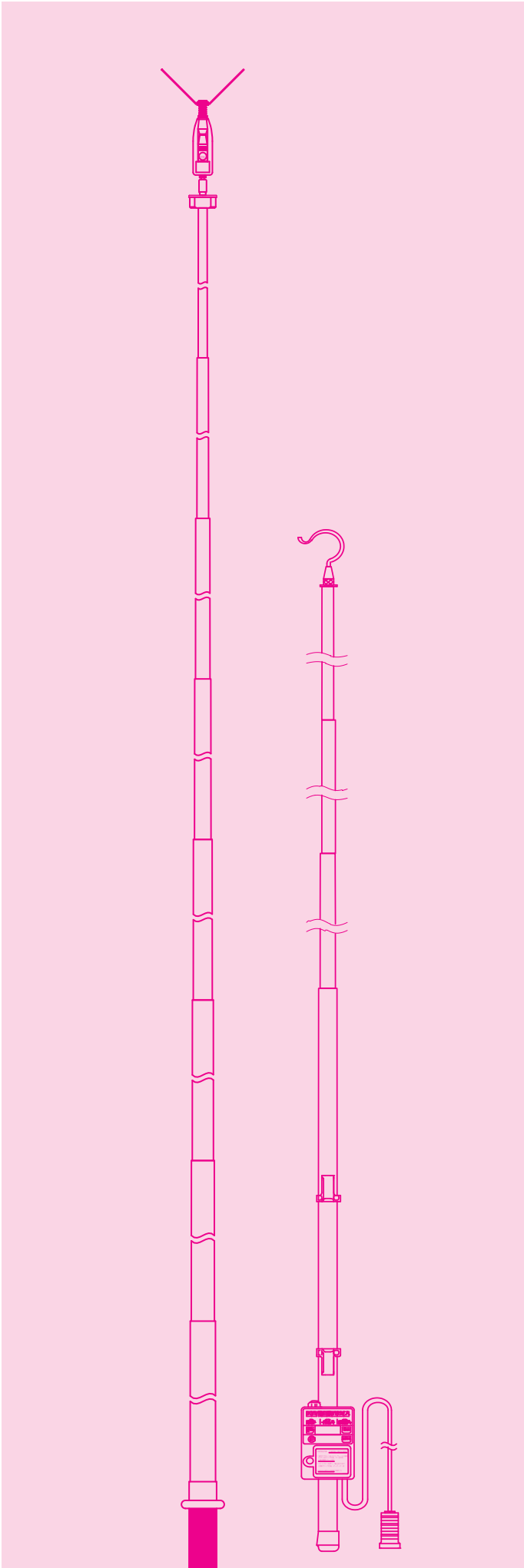

# Railway products

Information materials	Railway products	Illuminator	Measuring instrument	Discharge stick	Discone hook stick	Grounding hook	Phase tester	Voltage detector checker	Auxiliary device for voltage detection	Voltage detector	Index etc.
-----------------------	------------------	-------------	----------------------	-----------------	--------------------	----------------	--------------	--------------------------	--	------------------	------------

# HVC-1.5N3

Voltage detector for DC overhead contact wire

DC 1500V

- Audio signaling and light emitting
- Telescopic type
- Waterproof

## ■ Features

- Light weight body [About half weight compared with previous product.]
- Promote the checking before detect the voltage.
- Memorize the setting of volume control.
- Simplified the checking before detect the voltage.
- Adopt a strong Grounding magnet.
- Large Indication.

## Voltage Detector for DC 1500V Contact Wires, Visualization of decreasing Residual Voltage

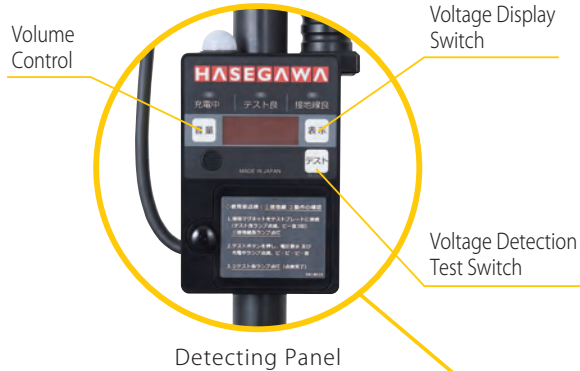

Detecting Panel

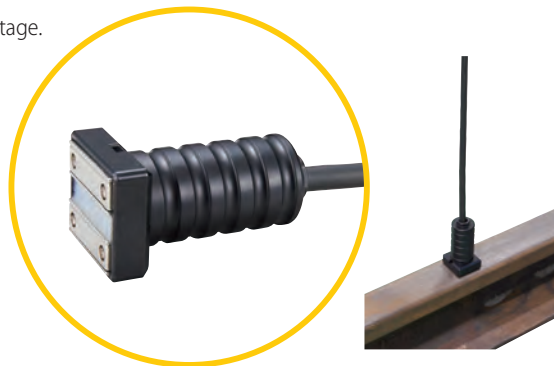

Grounding Magnet



## ■ Dimensions

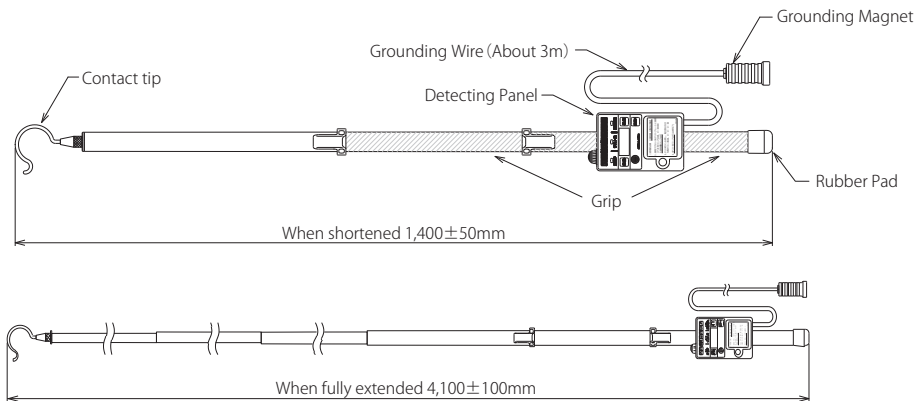

## ■ Specifications

Working voltage range	DC 1500V * Voltage detection of negative potential is not possible.	
Operation starting voltage (Voltage to ground)	DC750V ± 50V	
Display	Operation display (charging)	Red LED and buzzer
	Check of earth wire (Earth wire is OK)	Green LED
Voltage display	Range: 0 VDC to 1999 VDC Resolution: 1 V, Accuracy within ± 5% ± 5V	
Volume adjustment for buzzer sound	Each time when the sound volume push-button switch is pressed, the cycle of High → Medium → Low → High ---- is repeated. Sound volume at a distance of 1 m High: 75 dB or more Medium: 55 to 70 dB, Low: 50 dB or less	
Output voltage at test	DC1000V ± 200V	
Dielectric strength	Contact tip (Metal fitting) – Grounded part 4 kVAC, 1 min	
Leakage current	1 mA or less at dielectric strength test	
Battery	R6 or LR6(1.5V) × 4 pcs	
Operating temperature range	0°C ~ +50°C	
Weight	About 2.3kg	

## ■ Accessory



Bag for housing

# HVC-750N3

Voltage detector for DC third rail

DC 600V~1500V

Audio signaling and light emitting

Telescopic type

Waterproof

## ■ Features

- Promote the checking before detect the voltage.
- Memorize the setting of volume control.
- Simplified the checking before detect the voltage.
- Adopt a strong Grounding magnet.

## Voltage Detector for DC 750V Contact Wires, Visualization of decreasing Residual Voltage



## ■ Dimensions

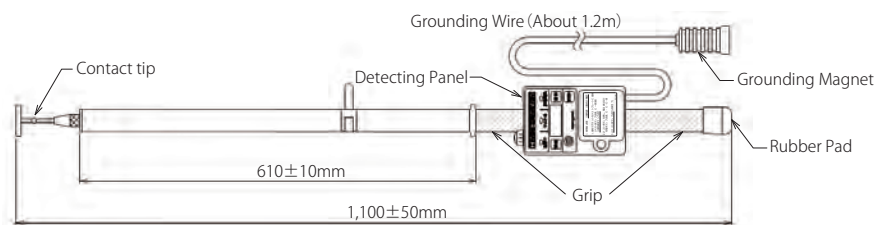

## ■ Specifications

Working voltage range	DC600V/750V/1500V * Voltage detection of negative potential is not possible.	
Operation starting voltage (Voltage to ground)	DC300V±20V	
Display	Operation display (charging)	Red LED and buzzer
	Check of earth wire (Earth wire is OK)	Green LED
	Voltage display	Range: 0 VDC to 1999 VDC Resolution: 1 V, Accuracy within ±5%±5V
Volume adjustment for buzzer sound	Each time when the sound volume push-button switch is pressed, the cycle of High → Medium → Low → High ----- is repeated. Sound volume at a distance of 1 m High: 75 dB or more Medium: 55 to 70 dB, Low: 50 dB or less	
Output voltage at test	DC500V±100V	
Dielectric strength	Contact tip (Metal fitting) – Grounded part 4 kVAC, 1 min	
Leakage current	1 mA or less at dielectric strength test	
Battery	R6 or LR6(1.5V) × 4 pcs	
Operating temperature range	0°C~+50°C	
Weight	About 1.4kg	

## ■ Accessory



Bag for housing

Index etc.
Voltage detector
Auxiliary device for voltage detection
Voltage detector checker
Phase tester
Grounding hook
Discone hook stick
Discharge stick
Measuring instrument
Illuminator
Railway products
Information materials



Index etc.  
Voltage detector  
Auxiliary device for voltage detection  
Voltage detector checker  
Phase tester  
Grounding hook  
Discharge hook stick  
Discharge stick  
Measuring instrument  
Illuminator  
Railway products  
Information materials

# HVC-1.5N3S

Voltage detector for DC substation

DC 1500V

音響発光 防滴



**HVC-1.5N3S**  
The plate is attached to grounding clip  
Inspection before use



It can be grounded in various place/et;c cubicle  
Please use two clips at the same time.

### ■ Dimensions

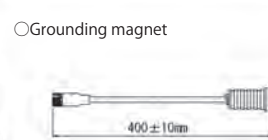
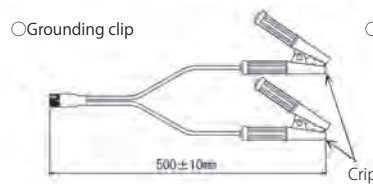
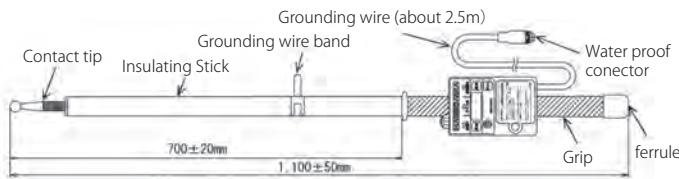

## Voltage detector for DC 1500V substation



■ Accessory



Bag for housing

### ■ Option



**HVC-1.5N3S**  
Grounding magnet  
(UH20004)



**HVC-1.5N3S**  
Grounding clip  
(UH20003)



**HVC-1.5N3S**  
The plate is attached to  
grounding clip  
Inspection before use  
(DH18007)

# HVC-1.5N3M

Voltage detector for monorail

DC 600~1500V

音響発光 防滴

### ■ Dimensions

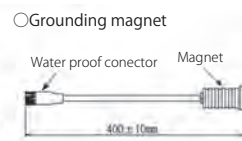
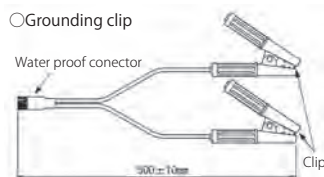
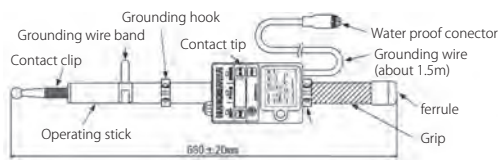

## Voltage detector for monorail



■ Accessory



Bag for housing

### ■ Option



**HVC-1.5N3M**  
Grounding magnet  
(UH20004)



**HVC-1.5N3M**  
Grounding clip  
(UH20003)



**HVC-1.5N3M**  
The plate is attached to  
grounding clip  
Inspection before use  
(DH18007)

### ■ Specifications

Model	HVC-1.5N3S	HVC-1.5N3M
Working voltage	DC1500V	DC600V/750V/1,500V
	Max DC2,000V (in contact with bare wire) *Voltage detection of negative potential is not possible.	
Operation strating voltage (Voltage to ground)	DC750V±50V	DC300V±20V
Insulation resistance	contact tip-grounding clip 10MΩ±10%(with 1,000Vmega measuring instrument)	
Dielectric strength	contact tip-grounding magnet AC4,000V,1 min	
Leakage current	1 mA or less at dielectric strenght test	
Operating temperature range	0°C~+50°C	
Volume adjustment for buzzer sound	Sound volume at a distance of 1m High:75dB Miidium:60dB or more 75dB or less Low:60dB or less	
Output voltage at test	DC1,000V±200V	DC500V±100V
Battery	R6 or LR6(1.5V) x 4 pcs	
Structure	Dustproof,Waterproof(Equivalent toIP44)	
Weight	About 1.8kg(with grounding clip)	About 1.6kg(with grounding clip)

# HS-1.5NJ HS-1.5NR

## Medium Voltage detector

**AC** 6600V

**DC** HS-1.5NJ: 600~7000V  
HS-1.5NR: 1000~7000V



## Voltage Detector of Dual Use for DC Contact Wire and AC 7kV



HS-1.5NJ



HS-1.5NR

### ■ Features

- Grounding wire options : Clip Type (HS-1.5NJ) and Magnet Type (HS-1.5NR)
- Discharging state of residual charge after power outage can be distinguished (HS - 1.5 NR)

### Operation display (HS-1.5NR)

Voltage		Green LED		Red LED and buzzer	
DC	AC	Lighting	Flashing	Lighting	Sound generation
After test and after voltage detection (not charged)		○	—	—	—
Approx. 350 to Approx. 750 V	Approx. 1,000 to Approx. 2,000 V	—	○	—	—
Approx. 750 V or more	Approx. 2,000 V or more	—	—	○	○

- When the green LED is flashing, a residual electric charge within the range of working voltages is being discharged.
  - A stand-by display function is provided. When the test button is pressed, the green LED lights for about 30 sec. (Voltage detection is possible, even if the green LED is turned off.)
- : Operation  
— : No operation

### ■ Dimensions

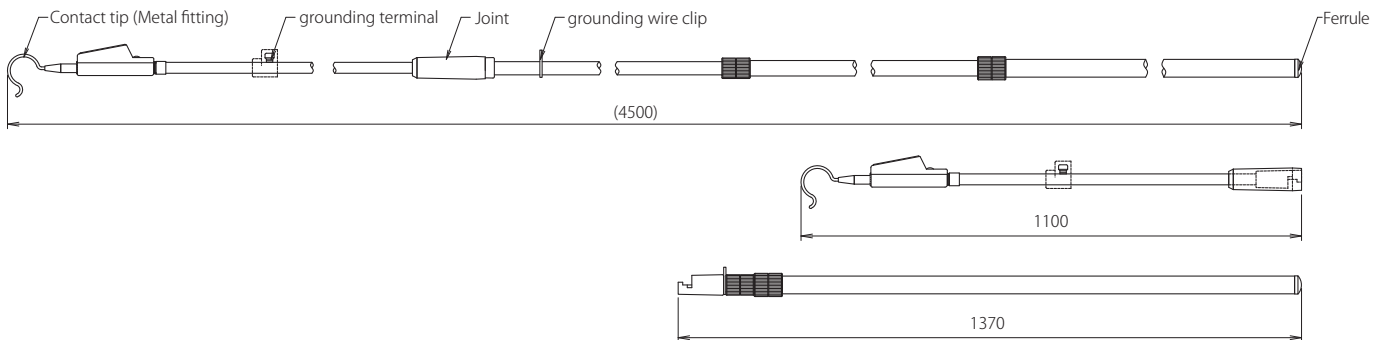

### ■ Accessory



Common bag for HS-1.5NJ/NR



Clip-type grounding wire (7 m)  
for HS-1.5NJ



Magnet-type grounding wire (7 m)  
for HS-1.5NR

### ■ Specifications

Model	HS-1.5NJ	HS-1.5NJ1	HS-1.5NR
Working voltage range	AC	6600V	
	DC	600~7000V	1000~7000V
Operation starting voltage (Voltage to ground)	AC	2000V±20%	
	DC	400V±20%	DC800V±100V
Frequency (AC)	50/60Hz		
Grounding system	Clip		Magnet
Indication of operation	Light	It can be confirmed in the luminance of 8,000 lux.	
	Sound	Intermittent sound	
Battery	6R61 or 6F22(9V) × 1 pcs		
Accessory	Clip type grounding wire (7 m)		Magnet type grounding wire (7 m)
	Bag for housing		
Weight	About 3,140 g		About 3,150 g
Dielectric strength	Between contact tip (metal fitting) and grounding terminal: 14,000 VAC, 5 min		
Leakage current	Leakage current at dielectric strength test: 1 mA or less		

Index etc.

Voltage detector

Auxiliary device for voltage detection

Voltage detector checker

Phase tester

Grounding hook

Discone hook stick

Discharge stick

Measuring instrument

Illuminator

Railway products

Information materials

# HST-W80JS

Voltage detector for AC overhead contact wire

AC 20kV~80.5kV



## ■ Features

- Standby display function is provided. After pressing the test button, the green LED lights up even after voltage detection. \* The green LED automatically turns off in 1 to 2 min.
- Voltage detection is possible even after turning off (in case there is no problem with battery level)

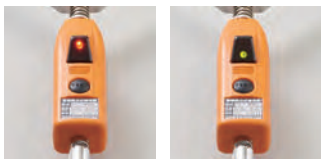

## ■ Dimensions

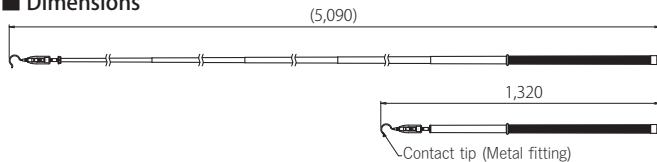

# Voltage Detector for AC Overhead Contact wires of normal Railways and Shinkansen



## ■ Accessory



Bag for housing

## ■ Specifications

Working voltage range	AC20kV~80.5kV	
Operation starting voltage (Voltage to ground)	5 kV ± 20% (bare wire)	
Frequency	50Hz/60Hz	
Indication of operation	Light	It can be confirmed in the luminance of 8,000 lux.
	Sound	50 dB or more at a distance of 2 m
Dielectric strength	Insulating stick, AC 75 kV/300mm x 1 min. (6 locations on the insulating stick, except for electrode and joints)	
Leakage current	100 μA or less at dielectric strength test/1 location	
Battery	LR44(1.5V) × 2 pcs	
Battery life	About 4 hr. continuous operation	
Operating temperature range	-10°C to +50°C (However, there shall be no dew condensation inside.)	
Weight	About 1 kg	

\* HST-W80JS-Y1 (spec. with Y-type Contact tip (Metal fitting) also exists.

# HXR-20J (For normal railways) HXR-25J (For high speed rail)

Medium Voltage hot-line proximity detector

AC HXR-20J 20kV  
HXR-25J 25kV

## ■ Features

- Alarm is generated at a distance of about 2 m from the energized overhead contact lines, normal railways (AC 20kV) and High Speed Railway (AC 25kV).
- It has directionality to identify overhead contact lines in a charged state.
- It is compact, lightweight, and can be fitted to a helmet with a one-touch operation

## ■ Dimensions (common to Model HXR-20J & Model HXR-25J)

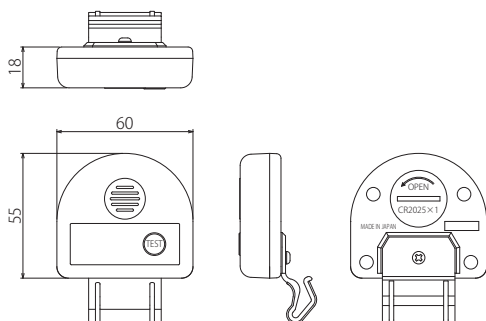

# Non-contact Detection of Charging State of AC Overhead Contact Lines

Jointly developed with JR EAST (East Japan Railway Company)



HXR-25J

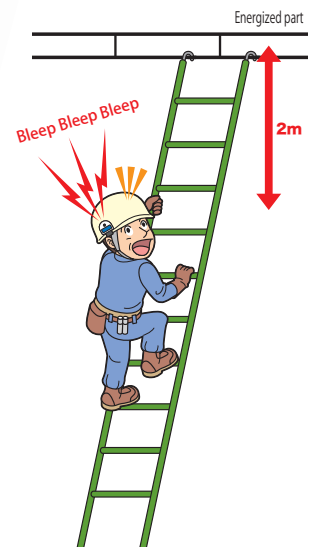

## ■ Specifications

Operating sensitivity (Electric field intensity)	HXR-20J : AC20kV HXR-25J : AC25kV
Standard operation starting distance	About 2 m (It differs depending on the environment)
Alarm operation	Piezoelectric buzzer type
Sound volume	80dB/10cm or more
Frequency	Common use for 50/60 Hz
Operating temperature range	-10°C ~ +40°C
Battery	CR2025(3V) x 1 pcs
Battery life	About two years in unused state
Dimensions	60mm x 55mm x 18mm
Weight	About 40g

# Grounding hook for railways

Custom production is possible with combination of tip metal fitting, length of operating rod, length and size of earth wire, and grounding metal fitting.

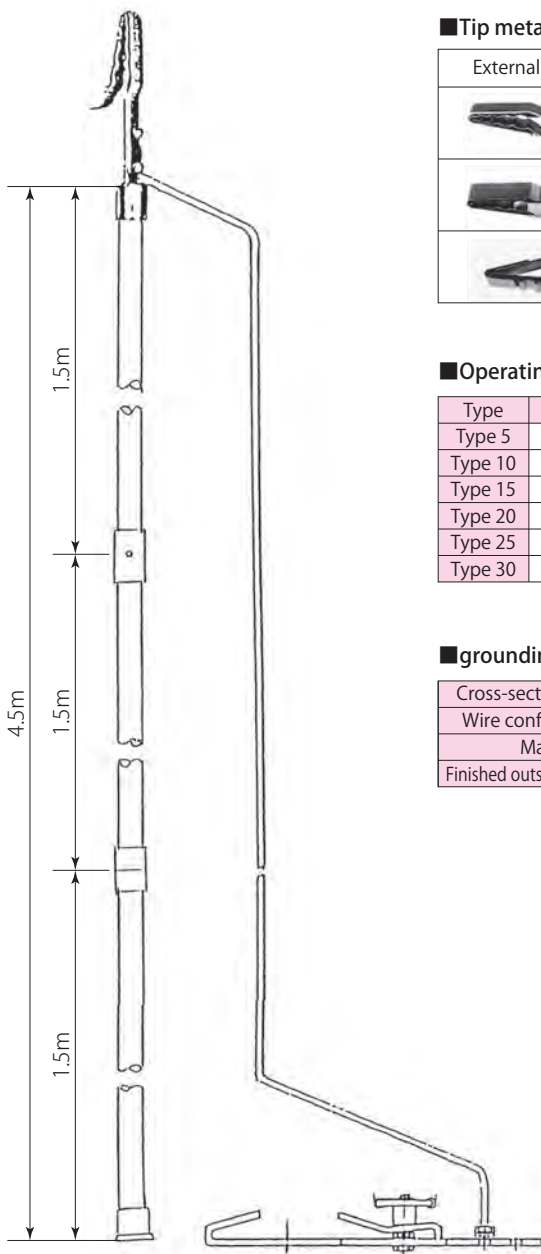

## Tip metal fitting

External appearance	Model name	Range of use (mm)	Dimension	Weight
	SA106-A Insertion type	$\phi 10 \sim 25$		630g
	SA106-C Slanted insertion type	$\phi 10 \sim 25$		720g
	SA106-S Compact insertion type	$\phi 4 \sim 10$		400g

## Operating stick

Type	Length	Length
Type 5	0.5m	Single rod
Type 10	1.0m	
Type 15	1.5m	
Type 20	2.0m	
Type 25	2.5m	
Type 30	3.0m	

Type	Length	Number of connections
Type 35	3.5m	Connection of 2 rods (1.5 m + 2.0 m)
Type 40	4.0m	Connection of 2 rods (2.0 m + 2.0 m)
Type 45-A	4.5m	Connection of 2 rods (2.0 m + 2.5 m)
Type 45-B		Connection of 3 rods (1.5 m + 1.5 m + 1.5 m)
Type 50	5.0m	Connection of 2 rods (2.5 m + 2.5 m)
Type 60-A	6.0m	Connection of 2 rods (3.0 m + 3.0 m)
Type 60-B		Connection of 3 rods (2.0 m + 2.0 m + 2.0 m)

## grounding wire

Cross-sectional area	38mm <sup>2</sup>	60mm <sup>2</sup>	100mm <sup>2</sup>
Wire configuration	19/38/0.26	19/60/0.26	37/51/0.26
Mass	455g/m	680g/m	1120g/m
Finished outside diameter	12.9mm	15.2mm	19.0mm

## Grounding metal fitting (SA120)

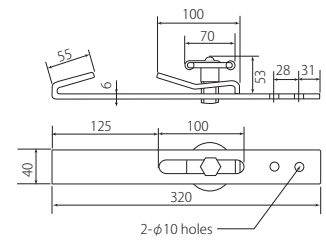

Mass: 1,000g

## Standard model

Type	Tip metal fitting	Grounding wire	Operating rod	Grounding metal fitting	Bag for housing
SA106A Type 45-A	SA106A	60mm <sup>2</sup> × 7m	4.5 m, connection of 2 rods (2.0 m + 2.5 m)	SA120	Sold separately
SA106A Type 45-B	SA106A	60mm <sup>2</sup> × 7m	4.5 m, connection of 3 rods (1.5 m + 1.5 m + 1.5 m)	SA120	Sold separately

Index etc.

Voltage detector

Auxiliary device for voltage detection

Voltage detector checker

Phase tester

Grounding hook

Discone hook stick

Discharge stick

Measuring instrument

Illuminator

Railway products

Information materials

Information materials	Railway products	Illuminator	Measuring instrument	Discharge stick	Discone hook stick	Grounding hook	Phase tester	Voltage detector checker	Auxiliary device for voltage detection	Voltage detector	Index etc.
-----------------------	------------------	-------------	----------------------	-----------------	--------------------	----------------	--------------	--------------------------	--	------------------	------------

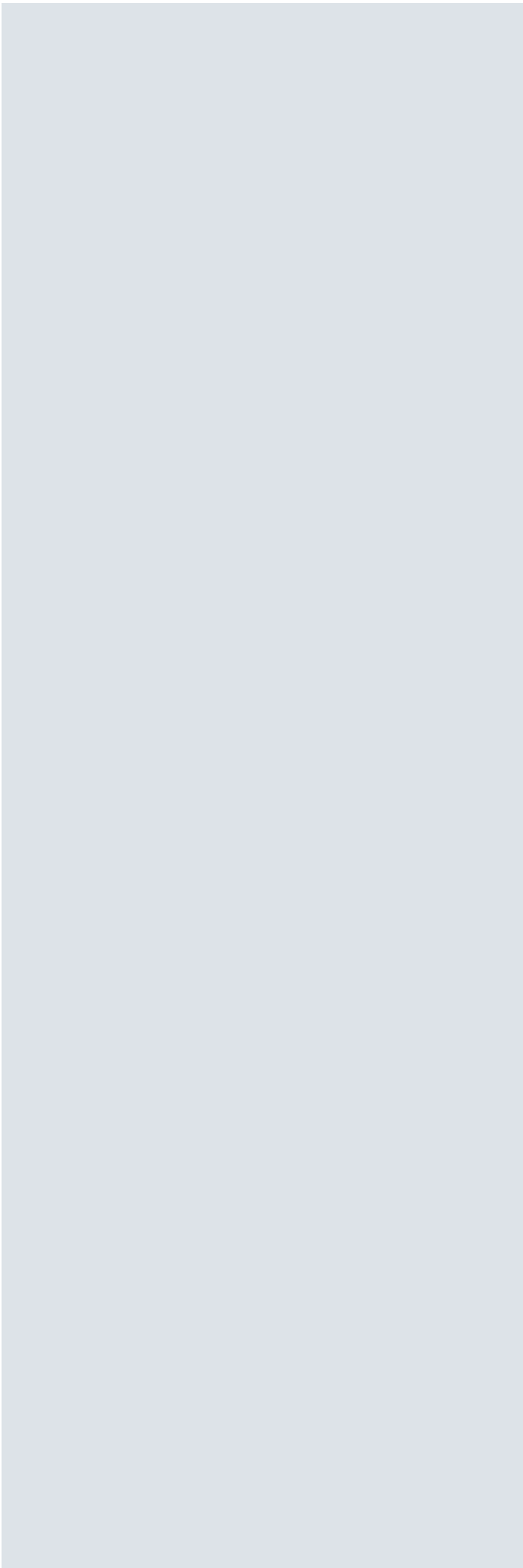

# Information materials

# Medium/Low voltage detector and its correct use

To prevent accidents during electrical work, extensive research has been carried out to improve facilities/equipment, working methods, and mechanical tools. Among those, the voltage detector for checking final charging status and electric power outages of circuits and apparatus onsite is an indispensable device for preventing electrical accidents.

During electrical work, it is not uncommon for electric shock accidents to occur due to mistaking live lines for lines with a power stoppage. It is important for workers to confirm without fail, that electricity lines do not have electricity flowing through them using a voltage detector before touching them. Their use is also required by OSH Regulations (Article 339).

A voltage detector is a device that detects whether electricity is flowing in a circuit or not. Various types of detector have been manufactured and are widely used. But, there was no official standard for the structure and performance of voltage detectors, and they were mainly manufactured according to the in-house specifications of users, such as electric power companies. However, since the electronic circuit voltage detector with a built-in battery was developed in recent years, detectors with complicated structures and unique modes of operating performance have been manufactured by various companies. Accordingly, the National Institute of Industrial Safety in Labor Ministry (at that time) released the Safety Guideline on the structure, performance, test method, and use of these voltage detectors, in order to make their selection and correct use well known.

The following explains the structure, performance, and correct use, mainly of high/low voltage detectors for AC circuits, which are in general use.

## 1. Structure and operating principle of voltage detector

### 1.1 Voltage detection of AC circuit

In general, voltage detectors have a structure with a detector built into a casing of insulation material. When the contact tip of the voltage detector makes contact with a cableway (electric circuit) as shown in Fig. 1, it detects minute electric currents  $I_0$  flowing in the Electric line  $\rightarrow$  Detector  $\rightarrow$  Stray capacitance to ground in the detecting part  $C_0$  of the detector  $\rightarrow$  Ground, and is activated. Then, it identifies the charging or electric power outage status of the circuit, indicating the result by lighting a lamp or sounding an alarm.

There are various types of voltage detector, depending on the working voltage, such as low voltage, high voltage, and special high voltage detectors, and according to the targeted application, such as for overhead lines and substations. There are many types of voltage detector including, for example, low voltage driver type or pencil type voltage detectors, which can easily check whether or not a voltage is applied to a household plug socket and to the cable terminals of electric appliances, as well as voltage

detectors used for construction work, inspecting electric power supply equipment, etc.

Among commonly used voltage detectors, the neon light emission type, which has the merits of a simple structure and not requiring a power supply, has been widely used. However, its weak luminance is a drawback when checking if its lamp is lit, which is a vital point. Accordingly, a better indication of detection than that provided by the discharge light emission from a neon tube has been required by users. Today, a voltage detector that can detect a voltage through an insulated cable and indicate it has been developed, with battery and amplifier circuit built in. This has become a commonly used type.

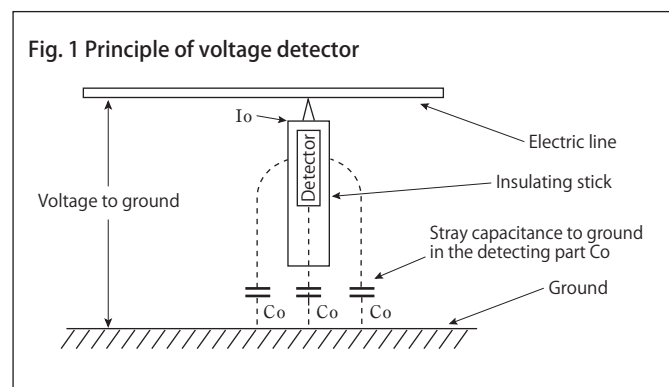

Fig. 1 Principle of voltage detector

Index etc.

Voltage detector

Auxiliary device for voltage detection

Voltage detector checker

Phase tester

Grounding hook

Discharge hook stick

Discharge stick

Measuring instrument

Illuminator

Railway products

Information materials

### ◆ Neon light emission type voltage detector (Fig. 2)

This made use of the feature whereby if a discharge voltage is applied to a neon discharge tube, it glows a brilliant orange color, even in the case of a minute current. It has been widely used for low, high, and special high voltage detectors, because its structure is very simple and it is easy to handle. Its drawback is that the weak light emitted is difficult to verify in well-lit areas, and voltage detection is not possible through the covering of an insulated cable.

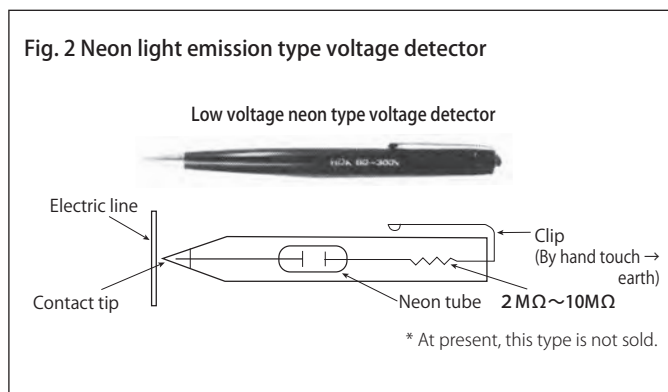

### ◆ Electronic circuit type voltage detector (Fig. 3) (Fig. 4)

This device identifies charging or electric power outage status by incorporating a battery and an electronic amplifier circuit with semiconductors inside the voltage detector. These amplify the minute detection current to light an easy-to-see indication lamp, and convert the current into an audio frequency to generate an easy-to-hear sound using the switching circuit and oscillating circuit.

The great advantage is that by designing an amplifier circuit it is possible to manufacture voltage detectors with various characteristics and to have the common type for high/low voltages, as well as to detect a voltage through an insulating sheath. Furthermore, because electronic circuit type voltage detectors are provided with a button for easily checking the battery and built-in circuit, it is easy to confirm a voltage detector's functions.

Fig. 3 Audio signaling and light emitting type low voltage detector (example)

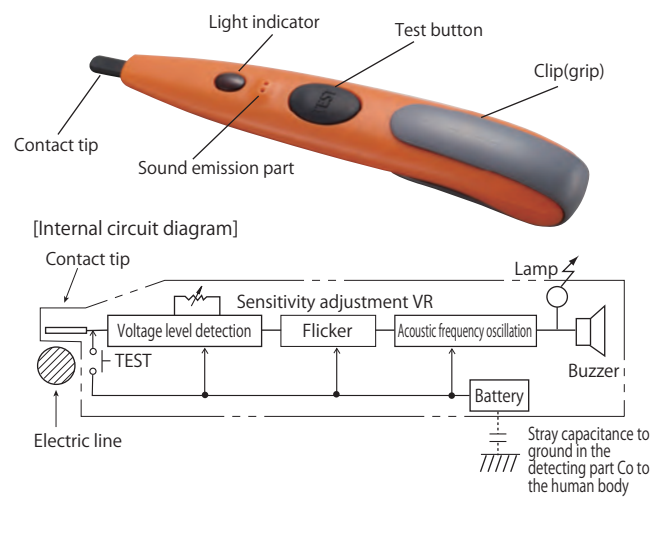
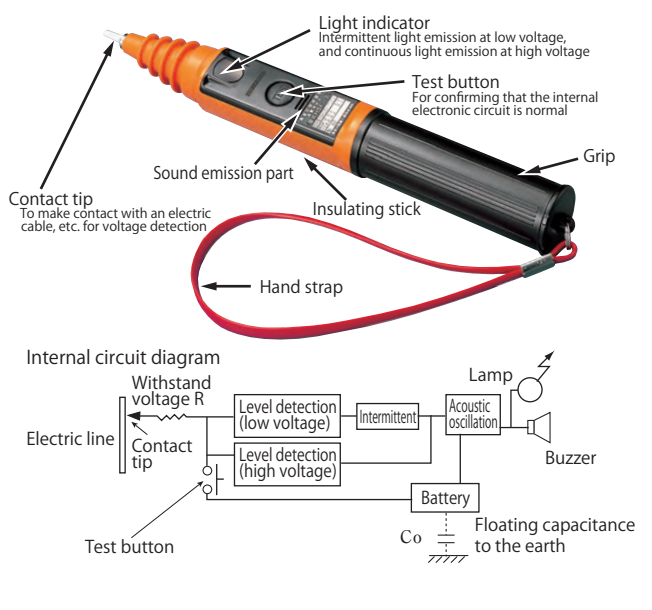
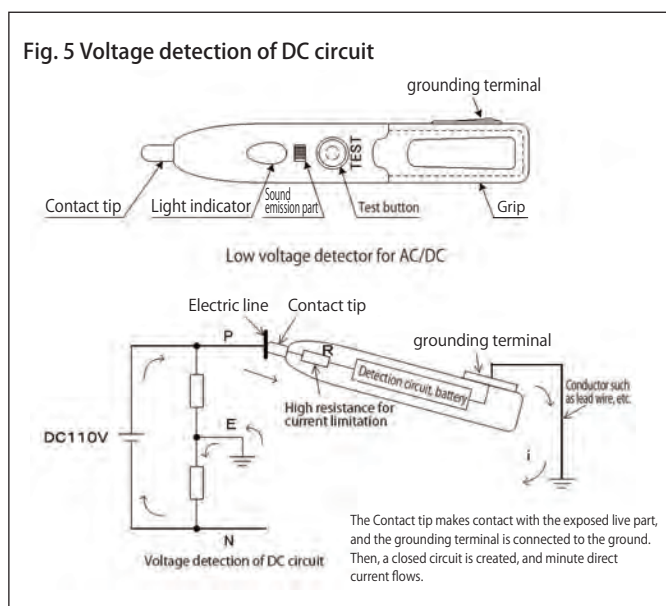

Fig. 4 Audio signaling and light emitting type high/low voltage detector (example)



## 1.2 Voltage detection of DC circuit

When detecting the voltage of a DC circuit, it is possible to have the contact tip make contact with an exposed live part of a electric line then create a closed circuit by connecting the earth terminal to the ground, and flow a direct current (Fig. 5), because the current does not flow via capacitance, unlike the case of AC. Therefore, voltage detection through a covering (sheath) is not possible in the case of a DC circuit. Furthermore, a voltage detector exclusively for AC use cannot detect a DC voltage. Moreover, voltage detection in a DC circuit with the cableway not grounded is impossible, because there is no return route for the current. The grounding system and voltage to the earth of the low voltage DC circuit are shown in Fig. 6.



As described above, because the voltage to the ground (target voltage to be detected) differs depending on the type of voltage, wiring, and grounding system, and the detection method also differs between AC and DC, a basic task of voltage detection is to identify the kind of Electric line (electric circuit) in which the voltage is to be detected, then select a suitable voltage detector, and execute voltage detection with the correct method.

Fig. 6 Grounding system and voltage to the earth of DC circuit

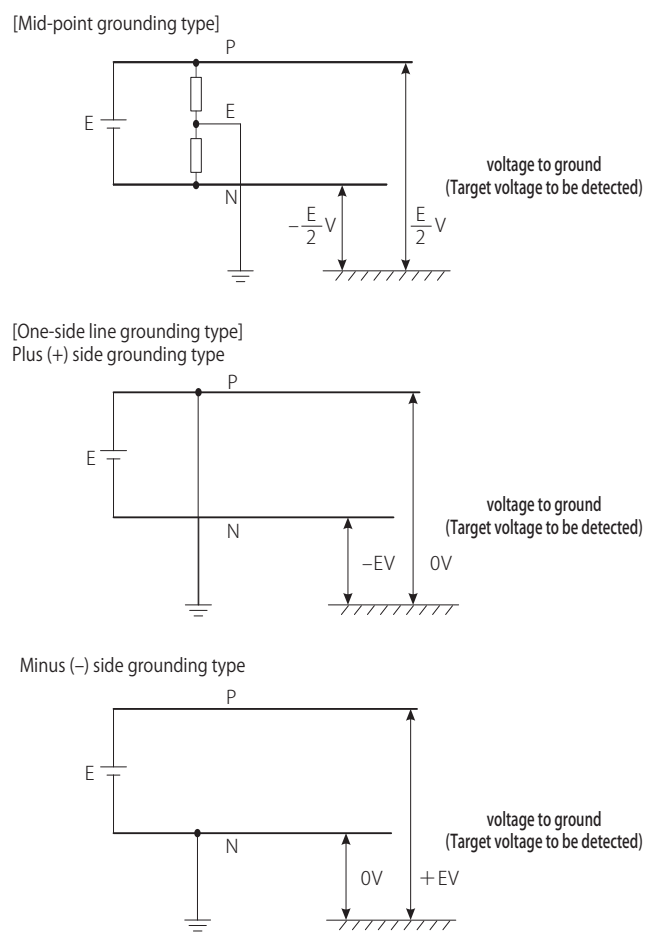

Index etc.
Voltage detector
Auxiliary device for voltage detection
Voltage detector checker
Phase tester
Grounding hook
Discone hook stick
Discharge stick
Measuring instrument
Illuminator
Railway products
Information materials



## 2. Performance required of voltage detectors

The first main performance priority from the viewpoint of a voltage detector's intended use is voltage detection sensitivity (operation starting voltage). It tends to be considered that as sensitivity increases, performance increases. However, as sensitivity increases, there are concerns that false-positive indications increase due to noise and/or induction. Other important things to consider are withstand voltage in terms of the safety of users, and indication method from the viewpoint of certainty.

### 2.1 Operation starting voltage (detectable minimum voltage)

In normal cases, a user of a voltage detector holds the main body or one end of the insulating stick connected to the main body with a hand(s), then makes contact between the detector and one line of the cableway, detecting the voltage flowing in the conductive cableway to the earth (voltage to the earth). Therefore, the operation starting voltage is indicated by the voltage to the earth.

The target voltage to be detected in a low voltage circuit and a high voltage circuit is the voltage to the earth, as shown in Fig. 7, which is lower than the line voltage. In addition, voltage detection in a grounded cableway (line) is naturally impossible, because the voltage to earth is zero.

(1) **The low voltage detector** generally targets the minimum circuit voltage, which is 100 V (95 to 107 V), and the operation starting voltage is set at  $65 \text{ V} \pm 15 \text{ V}$ , or not to exceed 80 V. In a voltage detector dedicated to low voltages, there is also a detector in which the voltage to the earth is set at 50 V or lower as the target (limit) under the OSH Regulations, because there is no need to consider the influence of induction from a high voltage.

(2) **Regarding a high voltage detector**, there are cases where a working voltage of 300 V or higher is specified as a high voltage, because the voltage to the earth is 254 V, with regard to a 440 V three-phase four-wire system, which is the highest voltage of a low voltage circuit. Furthermore, there is also a case where 600 V or higher can be detected, based on the regulation: "High voltage of

AC denotes the range of higher than 600 V to 7,000 V or lower;" specified in Technical Standards (ministerial ordinance).

In addition, in the case of a voltage detector dedicated to high voltages, there are various types depending on target cableways and applications, such as the case in which the voltage to earth of 1,900 V for a 3,300 V circuit is set at 1,000 V (almost 1/2) considering the margin for voltage detection, in order to prevent miss-operation due to induction from the live wire, as far as possible, and the case in which the working voltage is set at 3,300 V against the voltage to earth of 3,800 V for a 6,600 V circuit, considering the margin, and to enable voltage detection through a sheathed wire. In general, the value that enables detection of the voltage to earth for the targeted circuit's voltage, through a sheathed wire and with a

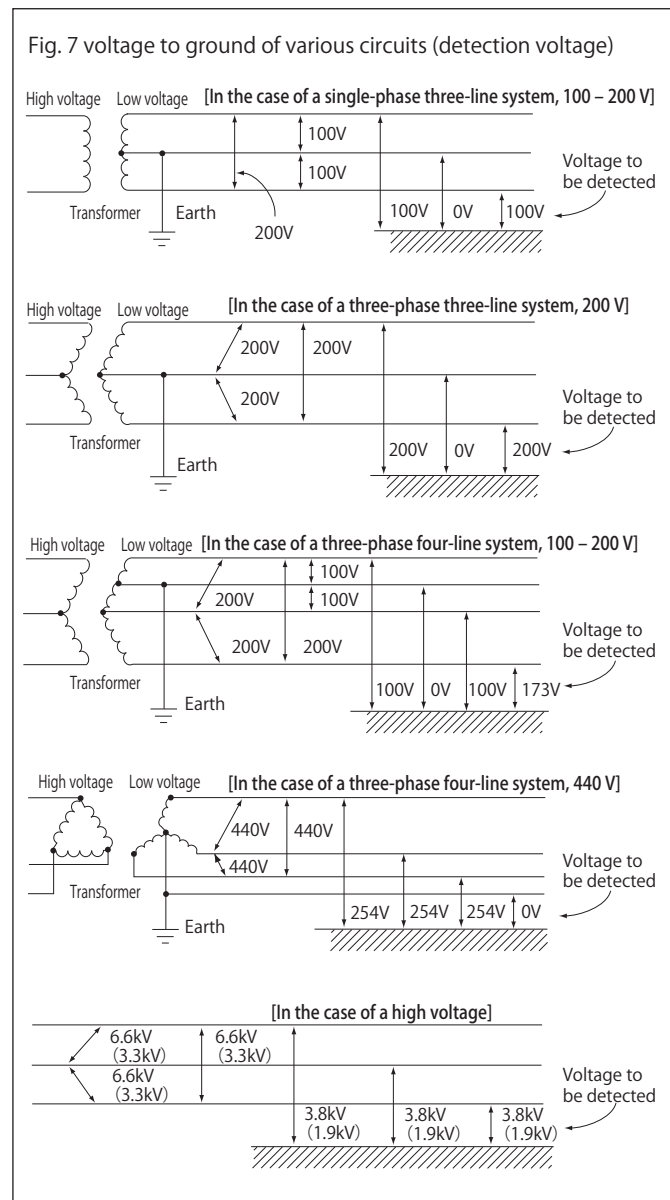

margin considered appropriate for safety, is used for voltage detection.

For comparison, **Table 1** shows a partial quoted example of an apparatus and supplies material standard for Japanese electric power companies.

**Table 1 Partial example of the apparatus and supplies material for a voltage detector**

	Operation starting voltage [V]		Remark
	Bare wire (a)	Coated wire (b)	
Company A	250 ± 50	(2,900 or less)	audio signaling and light emitting type
Company B	300 ± 50	(3,300 or less)	〃
Company C	1,000 or less	3,300 or less	〃
Company D	1000 ± 200	2800 ± 500	〃

(Note) (1) The reason why the ratios in column (a) and column (b) differ significantly between companies A, B and companies C, D is due to structural differences in the voltage detector.

(2) Although the values in ( ) of column (b) are not described in the apparatus and supplies material standard, they are used as practical standard values.

(3) That of company A is a common type for 50/60 Hz, and the others are dedicated to a designated frequency.

(4) The table above describes only the high voltage range of a high/low voltage detector.

(The low voltage range is specified as 65 ± 15 V by every company.)

## 2.2 Non-operation distance

When a voltage detector approaches a high voltage circuit, it is activated from a certain distance. However, if operation starts too far away, a phenomenon is generated whereby discriminating between live lines and non-energized lines among plural targets becomes impossible. Then, it is considered that, not only can the primary purpose of the voltage detector not be achieved, but it is also dangerous. Accordingly, it is common to specify a minimum distance for a system, beyond which operation is not started when the voltage detector approaches (called the non-operating distance), and in the case of a high voltage, the non-operating distance is usually 3 to 5 cm.

## 2.3 Withstand voltage

A high voltage detector is classified from the viewpoint of actual use for defective (porcelain) insulators, etc. among apparatus for live-line work, as described in the Public Notice of the Ministry of Labour No. 33, Article 9. Generally, it shall withstand an AC test voltage corresponding to two times the voltage of the target cableway to be used, for one minute. Regarding voltage detectors with a built-in battery, detectors having a withstand voltage performance of not only 14,000 V (6,900 V × 2), but also 20,000 V are manufactured,

## 2.4 Representation of the result of detection (light and sound)

It is specified that detection by voltage detectors shall be indicated by either light emission or sound generation (Safety guideline for voltage detectors).

Regarding indication by light emission, it is generally possible for light emissions to be identified if the luminance is 8,000 lux on a practical basis in shadow in sunlight (place without direct sunlight).

Regarding sound indication, it is also necessary to consider locations with high ambient noise of 80 dB, such as in the vicinity of roads in urban areas, when reviewing the usage environment of a voltage detector. However, a sound volume of 50 dB or more is deemed sufficient in practice, using sound generated at around 3,000 Hz, to which the sensitivity of a human's auditory sense is high, because ambient noise is generally in low frequency bands, which corresponds to the low tone range.

Index etc.
Voltage detector
Auxiliary device for voltage detection
Voltage detector checker
Phase tester
Grounding hook
Discone hook stick
Discharge stick
Measuring instrument
Illuminator
Railway products
Information materials

Index etc.
Voltage detector
Auxiliary device for voltage detection
Voltage detector checker
Phase tester
Grounding hook
Discone hook stick
Discharge stick
Measuring instrument
Illuminator
Railway products
Information materials

### 3. How to use voltage detectors correctly

#### 3.1 Check carefully before use.

Because a voltage detector is an important device for protecting the lives of workers, it must always be stored and handled carefully. External appearance as well as lighting should also be checked before use. Defective products must be replaced immediately.

- (1) Confirm whether the working voltage range of the voltage detector conforms to electric line or not.
- (2) Visually check for the presence or absence of breakages, dirt, flaws, cracks, etc. in the voltage detector.
- (3) Confirm that the detecting function of the voltage detector is normal, using a known power supply, voltage detector checker (Fig. 8), etc.
- (4) For a the voltage detector with a built-in battery, confirm that the internal circuit and battery voltage are normal by checking the mechanism (test button).

Fig. 8 Voltage detector checker

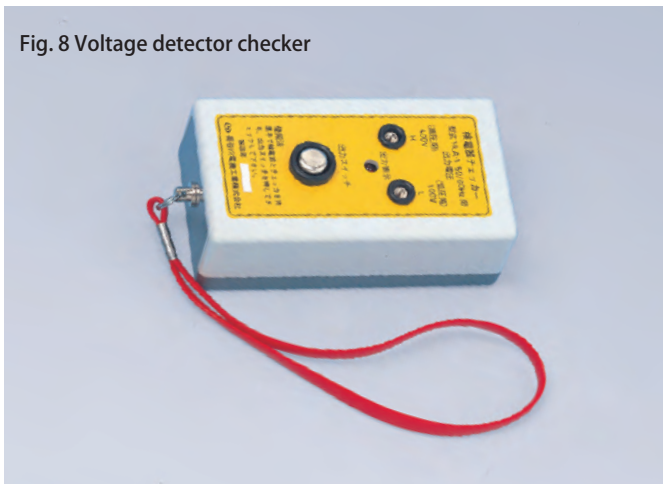

#### ■ Point to be noted about contact tip made of conductive rubber

Insulation materials such as oil shall not adhere to the conductive rubber part (detector). In particular, if gasoline, alcohol, etc. adhere, conductive properties can be lost.

Do not wipe it with chemicals, etc. When cleaning, use a soft and clean dry cloth.

#### 3.2 Points to be noted for voltage detection

- (1) Before voltage detection, confirm that the voltage detector corresponds to a suitable working voltage range

that conforms to the target cableway; (Example: A low voltage detector cannot detect high voltages). Also confirm the status of the cableway, with switches, indication lamps, and circuit diagrams, etc.

- (2) Set the insulating stick to the normal state by extending and/or tightening it, depending on the type of voltage detector.
- (3) During voltage detection, do not touch parts other than the grip of the voltage detector, because this may be dangerous.
- (4) When detecting a high voltage, wear insulated rubber gloves when a hand approaches within a distance of 60 cm from the high-voltage part. If an ordinary voltage detector with a length of 25 cm is used, be sure to wear insulated rubber gloves. In the case of an inspection tour, and if protective equipment and/or protective guard are not carried, it is convenient to use a long voltage detector with an insulating stick.
- (5) When there is a risk of a surge voltage being generated, such as when a lightning strike occurs or when opening/closing a circuit breaker, switch, etc., stop using the voltage detector.
- (6) Voltage detection in the rain should be avoided, in principle. When it is performed from sheer necessity, pay attention to the wet condition of the voltage detector, and whether operation in the rain is reliable or not. It is also necessary to investigate and confirm whether there is a risk of electric shock or not.
- (7) Perform voltage detection for each phase, sequentially.
- (8) Perform voltage detection by moving the voltage detector closer from the earth side to the electric line.

#### 3.3 How to make contact with a voltage detector

Hold the grip of a the voltage detector firmly, and have it make contact with the part targeted for voltage detection. When detecting voltage through a covered (sheathed) wire, ensure sufficient contact between the detector and the wire as shown in Fig. 9. Otherwise, capacitance between the core wire and detection metal fitting changes, and operating sensitivity decreases.

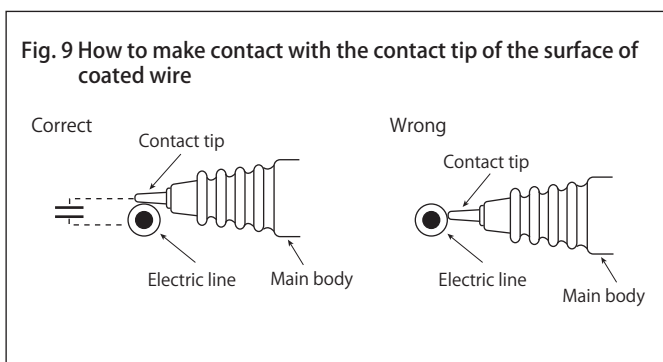

### 3.4 Voltage detection for a high voltage electric line is not possible.

Voltage detection for the high voltage power cable is not possible because the conductor is shielded and grounded with conductive tape. (Fig. 10)

Perform voltage detection at the terminal that is specially provided at the cable end for detection, using a dedicated voltage detector. Furthermore, there are also cases of using a current detector for detecting a current that flows in a cable.

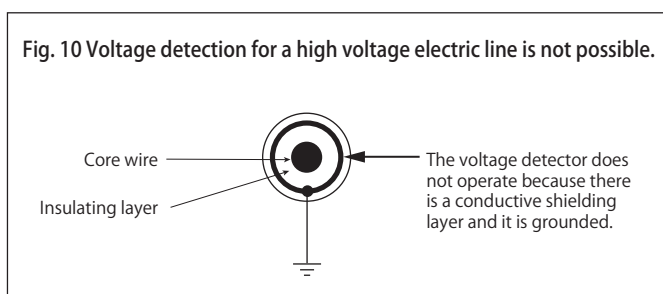

### 3.5 Electric discharge of residual charge

When there are electric power cables, power capacitor, etc. on the cableway, it can be hazardous even with an AC cableway, because a residual DC charge remains after an electric power outage. In the OSH Regulations No. 339 Article 2, it is specified that “Regarding a cableway where its open-circuit has power cables, power capacitor, etc. and there is a risk of danger due to residual charge, the corresponding residual charge must be securely discharged with a safe method,” and it is necessary to completely discharge the residual charge with a discharge bar or similar means. At this time, there are cases of a charge remaining between the cableway and the earth, and cases of it remaining between lines. So, discharge all residual charges with care. In addition, it is nec-

essary to take sufficient time when discharging, because there are also cases in which it takes a long time for discharging, depending on the resistance value of a discharge resistor and capacity of a condenser.

Moreover, when the residual charge is checked, use a voltage detector for dual AC/DC use, and perform voltage detection for the electric potential at both ends where the electric charge remains (Fig. 11).

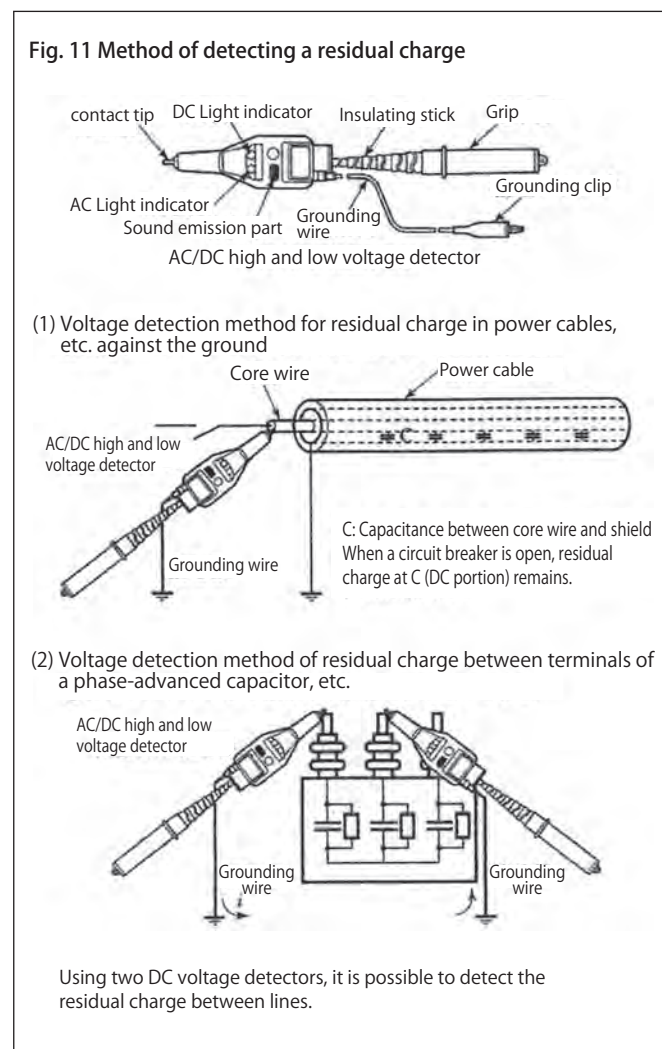

### 3.6 Precautions for carrying and storage

- (1) Handle voltage detectors carefully, and pay attention not to apply a shock or strong force, caused by dropping, placing a heavy object on top, etc.
- (2) Pay attention not to leave it on a road or at a place that is subject to high temperatures, such as inside a car in summer.
- (3) In winter, when a voltage detector is suddenly brought out from a hot room to the cold outdoors or the reverse, dew condensation can be generated at the volt-

Index etc.
Voltage detector
Auxiliary device for voltage detection
Voltage detector checker
Phase tester
Grounding hook
Discone hook stick
Discharge stick
Measuring instrument
Illuminator
Railway products
Information materials

age detector, and its operating functions may be affected. So, attention is required.

(4) For storage, select a dry, clean dust-free location inside a room, which is not exposed to direct sunlight.

### 3.7 Don't forget to conduct periodic inspections

Voltage detectors are excluded from periodic self-inspections as determined by the law (Ordinance on Industrial Safety and Health). However, unlike work tools such as pliers and screwdrivers, voltage detectors are important safety equipment used to prevent electric shock disasters for workers in electric-related activities. As such, it is preferable to periodically check the voltage-resistance performance of voltage detectors. (Voltage Detector Safety Guidelines)

(1) For high and extra-high voltage detectors, the following periodic self-inspections are recommended according to the product.

- Short-type voltage detectors for high/low voltage (HSF-7, HSE-7T1, HSE-7G)

Please conduct a voltage-resistance test for 1 minute at a test voltage of 10 kV or higher once a year. (Voltage Detector Safety Guidelines RIIS-TR-85-2)

- Other models not included above (including phase testers)

Please conduct a voltage-resistance test for 1 minute at 2x the maximum working voltage once every six months.

(In conformance with Article 351 of the Ordinance on Industrial Safety and Health (Periodical Self-Inspection of Personal Insulating Protective Equipment, etc.) and Article 9 of the Standards for Personal Insulating Protective Equipment, etc. (Voltage Resistance Performance of Live Line Work Equipment)) \*For testing methods, refer to P. 72 and P. 74.

(2) When conducting a periodic inspection, check and change the batteries that have been included with the voltage detector, as the individual batteries experience natural discharge even if the voltage detector is not used.

## 4. Influence of unique usage conditions

The site environments where voltage detectors are used are not always the same, and detection performance sometimes changes depending on usage conditions. The conditions with notable influences are as follows.

### 4.1 When the correct position of the grip is not identified:

If the grip of a commonly used short voltage detector is not held firmly, and when it is used in a state in which it is only held by finger tips, the operation starting voltage increases because the value of capacitance  $C_1$ , as shown in the equivalent circuit of **Fig. 12**, decreases.

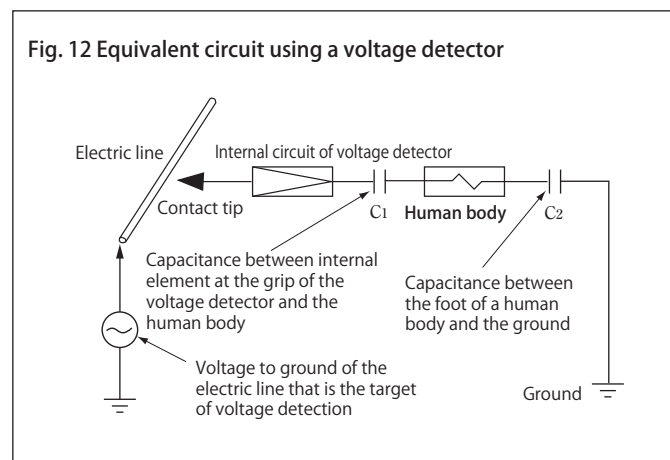

### 4.2 When voltage detection is performed near a high voltage electric line:

When the detector of a high/low voltage detector (with built-in battery) makes contact with an earth wire or grounded metal while approaching a high voltage live part on a pillar or inside an electric utility room, the voltage detector sometimes displays “Voltage is applied,” in the range of low voltage use.

This phenomenon is explained, as shown in **Fig. 13**, as the human body and/or grip of the voltage detector that approaches the high voltage line having a voltage that flows to the earth due to induction from the live line, and an induction current flows in the reverse direction from the grip of the voltage detector to the detector, causing it to operate. In such a case, abnormal operation can be prevented by keeping it as far as possible from the high voltage line, or carrying the voltage detector from the earth side, because induction is decreased.

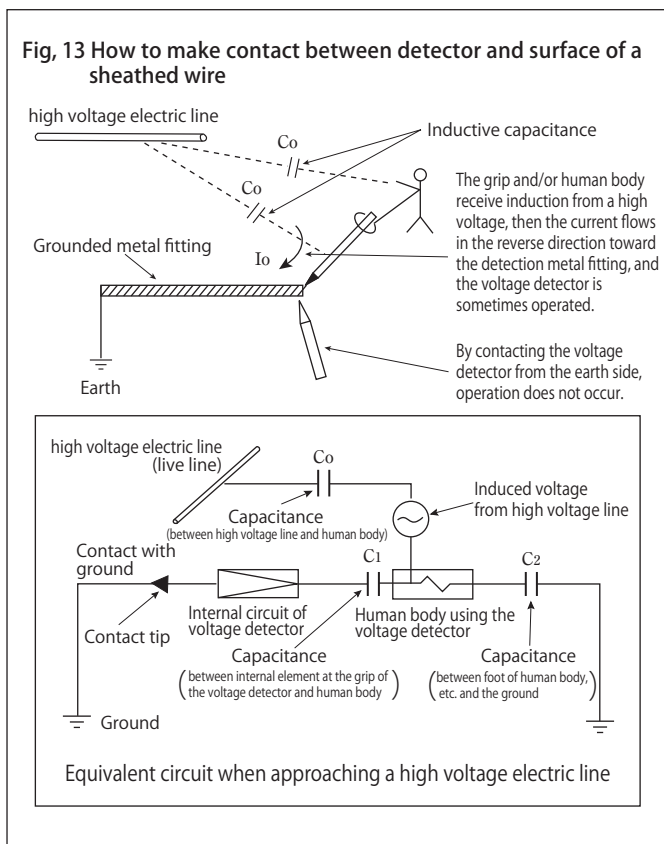

### 4.3 In the case of apparatus that is not grounded:

To reduce the inflowing current to the human body to a very small value, the impedance between the detector and the human body is increased to a very large value. Accordingly, when the casing of the apparatus is not grounded as shown in **Fig. 14**, the voltage detector sometimes gives an indication when the inductive capacitance of the apparatus is large, even if the insulation of the target apparatus is normal.

In such a case, it is necessary to confirm whether the grounding of the apparatus is perfect or not. Furthermore, in the case of apparatus that is not grounded, measure the voltage to verify if it is in a safe range or not using a meter with a relatively low impedance, such as an analog tester.

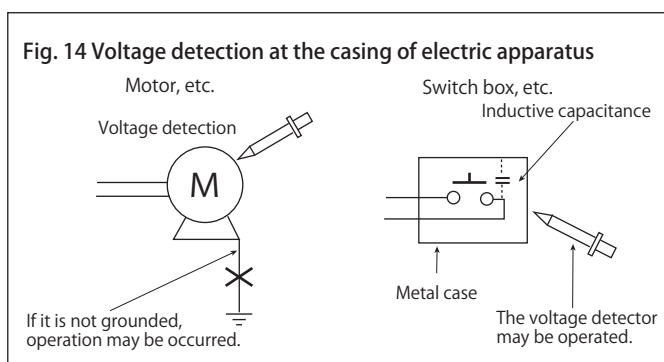

※ ※ ※ ※

A comprehensive explanation of high/low voltage detectors has been provided above. Again, because voltage detectors are important items for ensuring safety during electrical work, correct use with sufficient recognition of the system/mechanism is naturally required. We hope this document helps ensure correct use of voltage detectors. For details of quoted regulations, etc., refer to the following.

- OSH Regulations No.339 (Work following an electric power outage)
- OSH Regulations No.342 (Work in proximity to a high voltage)
- OSH Regulations No.348 (Electrical insulating protectors, etc.)
- OSH Regulations No.352 (Inspection before use, etc.)
- OSH Regulations No.354 (Exclusion from application)
- Public Notice of the Ministry of Labour No.33 (revised version), 1975 (Standard of protectors for insulation, etc.)
- Technical guideline of National Institute of Industrial Safety in Labor Ministry  
RIIS ~ TR ~85~2  
(Safety guideline for portable voltage detector for high voltage wiring cableway)

Index etc.
Voltage detector
Auxiliary device for voltage detection
Voltage detector checker
Phase tester
Grounding hook
Discone hook stick
Discharge stick
Measuring instrument
Illuminator
Railway products
Information materials

# Product Warranty, Maintenance

Index etc.
Voltage detector
Auxiliary device for voltage detection
Voltage detector checker
Phase tester
Grounding hook
Discone hook stick
Discharge stick
Measuring instrument
Illuminator
Railway products
Information materials

## ■ Warranty period

- Product warranty period is one year after purchase. If any failure, trouble, etc. is caused during normal use in the course of the warranty period, we will repair or replace it free of charge.

## ■ Scope of warrantee

- If disassembly, modification, etc. is performed by customers, the product becomes outside the scope of warranty.
- Consumable parts such as batteries attached to products, etc. are outside the scope of warranty. Furthermore, because attached batteries are provided for the purpose of confirming operation, early replacement is recommended.

## ■ Repair

- If the product malfunctions, please inquire at a sales office of our company or a sales agent. Requests for repair will be received through sales agents.
- When an estimate before repair is needed, please request it when asking for the repair. When declining repair after submission of the "estimate before repair," the cost of diagnosis will be requested.
- Warranty period after repair is six months. Scope of warranty is limited to the corresponding portion(s) repaired, and even within that warranty period, any new problem arising is outside the scope of warranty.

### [Period for repair]

Materials and components for repair are kept for a minimum of five years after stopping manufacture of a product. However, please note that there are cases in which repair can become impossible before that period has expired.

## ■ Recommended period for replacement

### (voltage detector, phase tester, auxiliary device for voltage detection, etc.)

Products can be used for a long period if they are handled with sufficient care. However, it is inevitable that functional deterioration occurs to the strength of components, insulation performance, etc. due to aging, micro-cracks caused by shocks when handling resin parts, etc. For safety, please use the product until the recommended time for replacement under product control. The table to the right summarizes recommended replacement periods.

For a detailed table, please inquire at our company's homepage (URL is given on the back cover of the catalog) or a sales office.

Product classification	Recommended period for replacement
Low voltage detector	3 to 5 years
High voltage detector	5 to 7 years
High voltage & special high voltage detector	
High voltage & special high voltage detector (Non-extendable type)	5 to 10 years

### ■ Periodic inspection, calibration test

- For high voltage and special high voltage detectors, we recommend periodic inspection at least once a year. For requests, please inquire at a sales office of our company, or a sales agent.
- After the calibration test, we will issue a test report, calibration certificate, and traceability certificate.
- If calibration documents are required when purchasing a new product, please request them when placing an order.

### ■ Consigned testing

Taking advantage of being a leading maker of domestic test equipment and many years of experience, we will execute withstand voltage tests for products even made by other companies.



Voltage detector test equipment



Simulated power pole for electricity distribution line

### ■ ISO management system Acquiring certification of ISO9001, ISO14001

Hasegawa Electric Co., Ltd. has acquired certification of "ISO9001," which is the international standard of the Quality management system, and certification of "ISO14001," which is the international standard of the Environment management system.

ISO9001 Registration No.: 0921

ISO14001 Registration No.: E635



Index etc.
Voltage detector
Auxiliary device for voltage detection
Voltage detector checker
Phase tester
Grounding hook
Discone hook stick
Discharge stick
Measuring instrument
Illuminator
Railway products
Information materials



# In order to use the voltage detector correctly

\*Unauthorized copying and reproduction is prohibited

## Low voltage use (For AC)

The contact area with the hand affects the sensitivity of the voltage detector. So, appropriate sensitivity cannot be obtained unless it is held firmly. Also, it is not possible to use rubber gloves for high voltages or gloves made from thick fabric.

### ■ Holding the voltage detector correctly

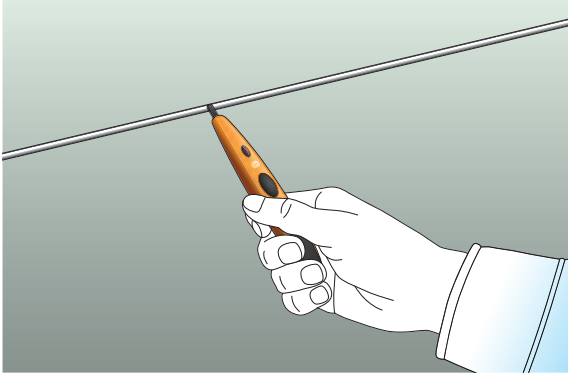
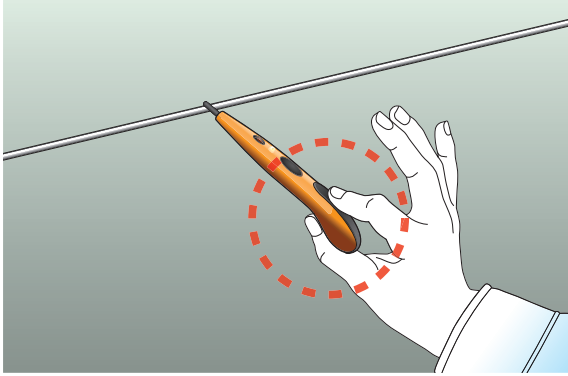
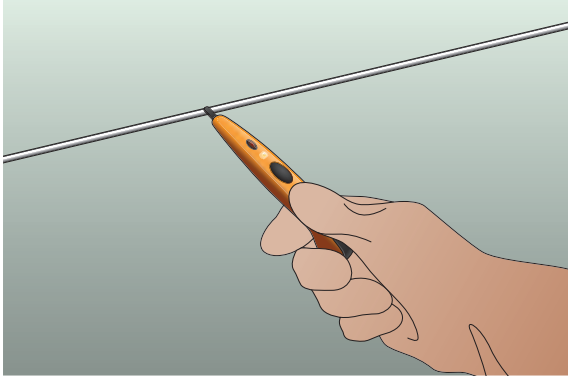
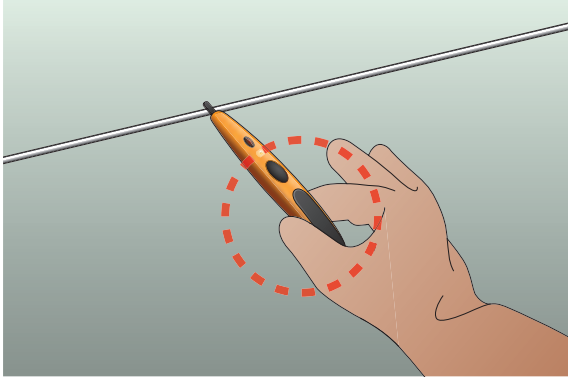
○ Good	✗ Bad
	
	
<p>● Hold the grip firmly.</p>	<p>● It is not possible to detect the voltage correctly if the grip is held with the tips of the fingers.</p>

### ■ Visual inspection

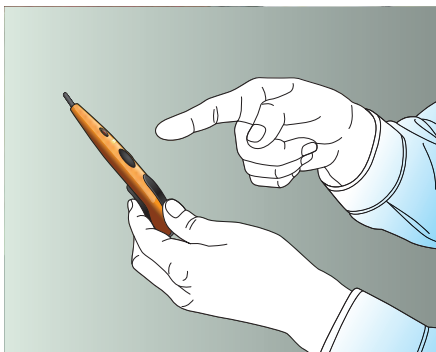

#### Visual inspection items

- Press the test button for about five seconds and check that there is no change in the lamp or the sound.
- Check that there are no problems such as damage, dirt, scratches or cracks.

### ■ Withstand voltage testing

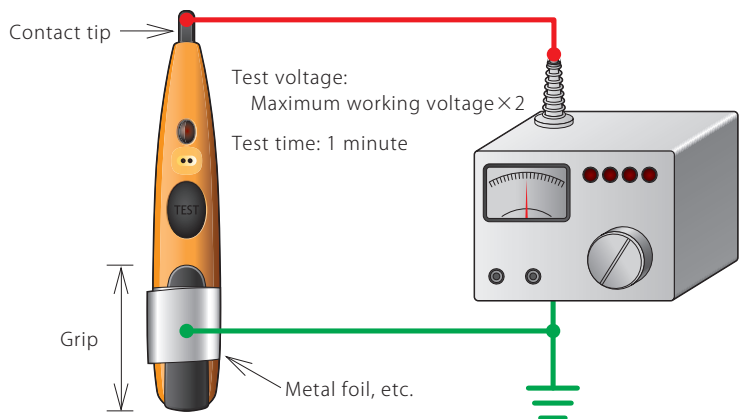



- Apply a voltage between the contact tip and the grip (at a position near the contact tip).

## Medium and Low voltage use (For AC)

The contact area with the hand affects the sensitivity of the voltage detector. So, appropriate sensitivity cannot be obtained unless it is held firmly.

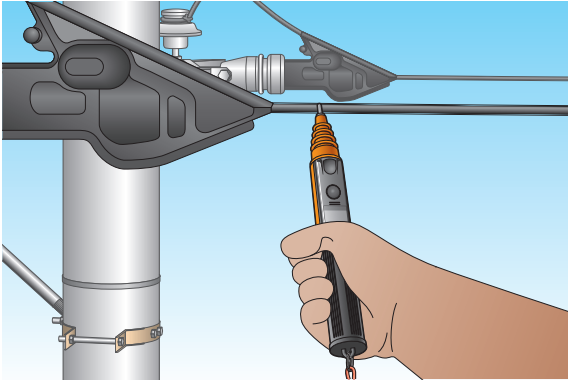
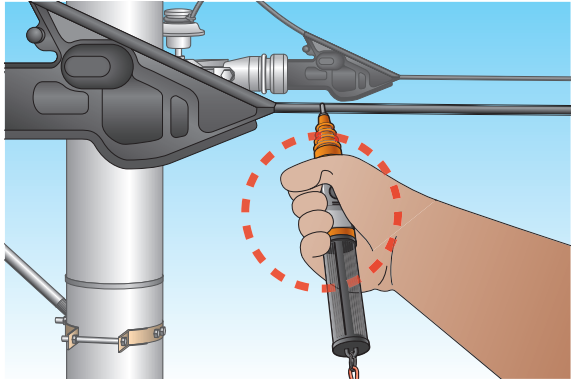
### ■ Holding the voltage detector correctly

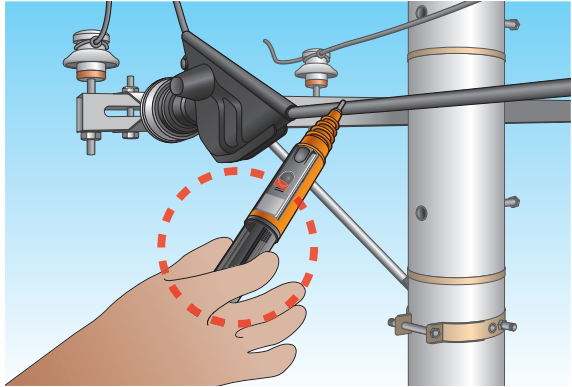
○ Good	✗ Bad
	
	
<p>● Hold the grip firmly.</p>	<p>● Never hold a part other than the grip when detecting voltages. This is extremely dangerous.</p> <p>● It is not possible to detect the voltage correctly if the grip is held with the tips of the fingers.</p>

### ■ Visual inspection

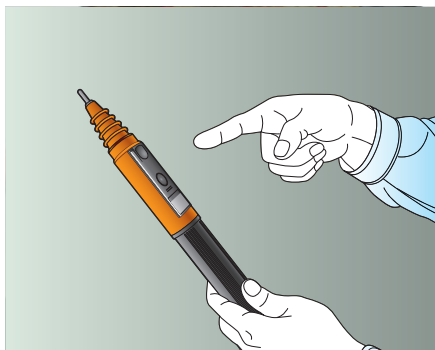

#### Visual inspection items

- Press the test button for about five seconds and check that there is no change in the lamp or the sound.
- Check that there are no problems such as damage, dirt, scratches or cracks.

### ■ Withstand voltage testing

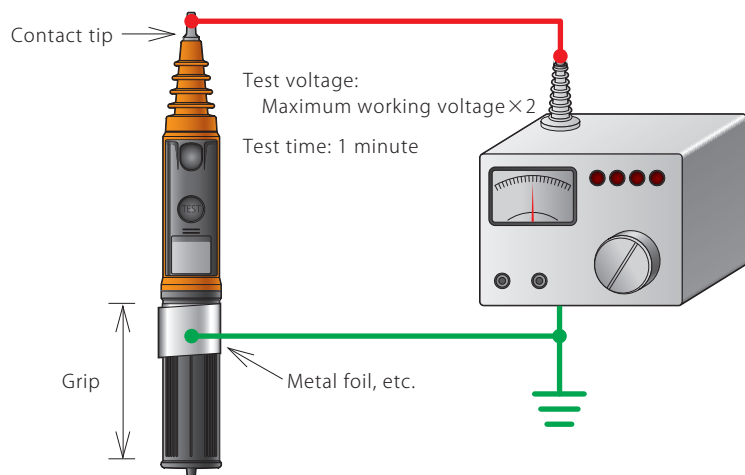

- Apply a voltage between the contact tip and the grip (at a position near the contact tip).

Index etc.

Voltage detector

Auxiliary device for voltage detection

Voltage detector checker

Phase tester

Grounding hook

Discharge hook stick

Discharge stick

Measuring instrument



Illuminator

Railway products

Information materials

# Medium voltage & High voltage detector use

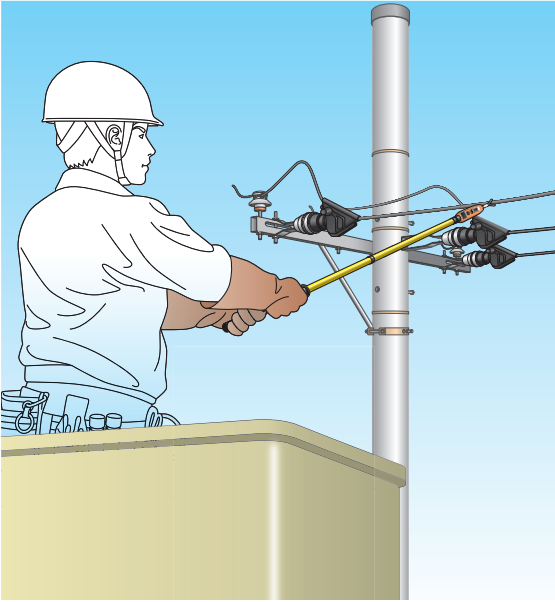
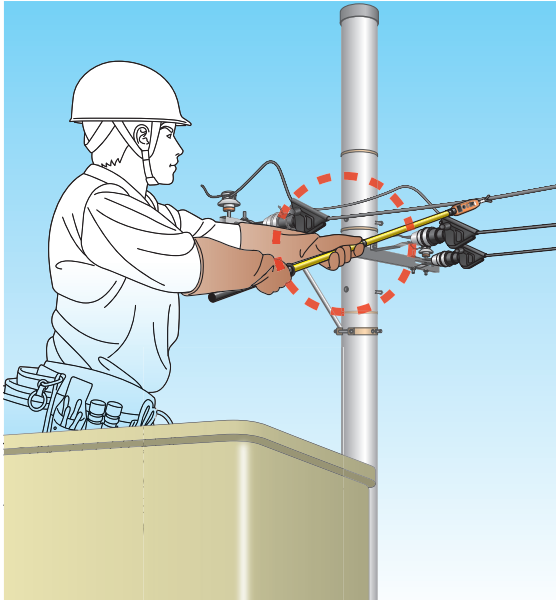
## ■ Holding the voltage detector correctly

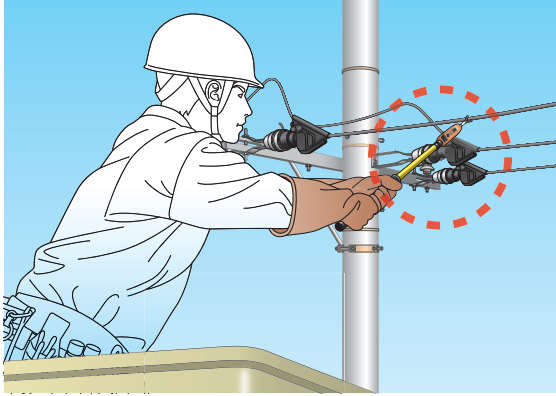
○ Good	✗ Bad
	
<p>■ During storage</p>  <p>↓</p> <p>■ During use</p>  <p>Extend as far as possible</p>	
<ul style="list-style-type: none"> <li>● Hold the grip firmly.</li> <li>● Telescopic type voltage detectors should be extended as far as possible for use.</li> </ul>	<ul style="list-style-type: none"> <li>● Never hold a part other than the grip when detecting voltages.</li> <li>● Do not use a telescopic type voltage detector to detect voltages in its shortened state.</li> </ul>

## ■ Visual inspection

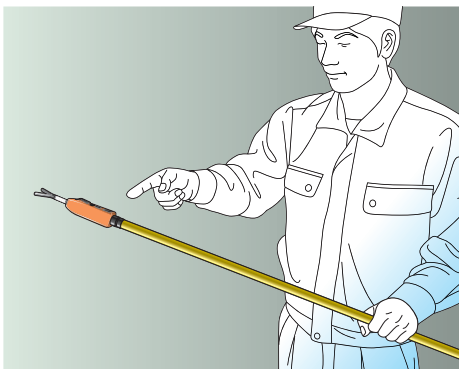

### Visual inspection items

- Press the test button for about five seconds and check that there is no change in the lamp or the sound.
- Check that there are no problems such as damage, dirt, scratches or cracks.

## Withstand voltage testing

When using a withstand voltage tester output voltage (MAX 75 kV)

When the test voltage exceeds 75 kV

Divide the test points into parts 30 cm long and apply the test voltage across each of those parts

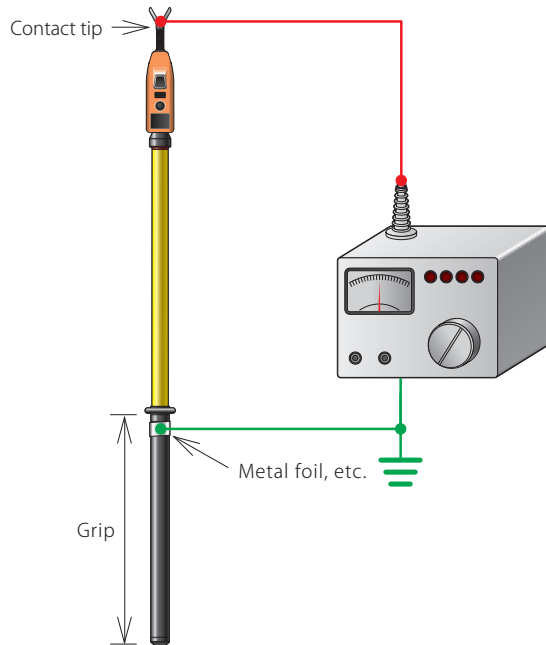

Test voltage: Maximum working voltage × 2  
Test time: 1 minute

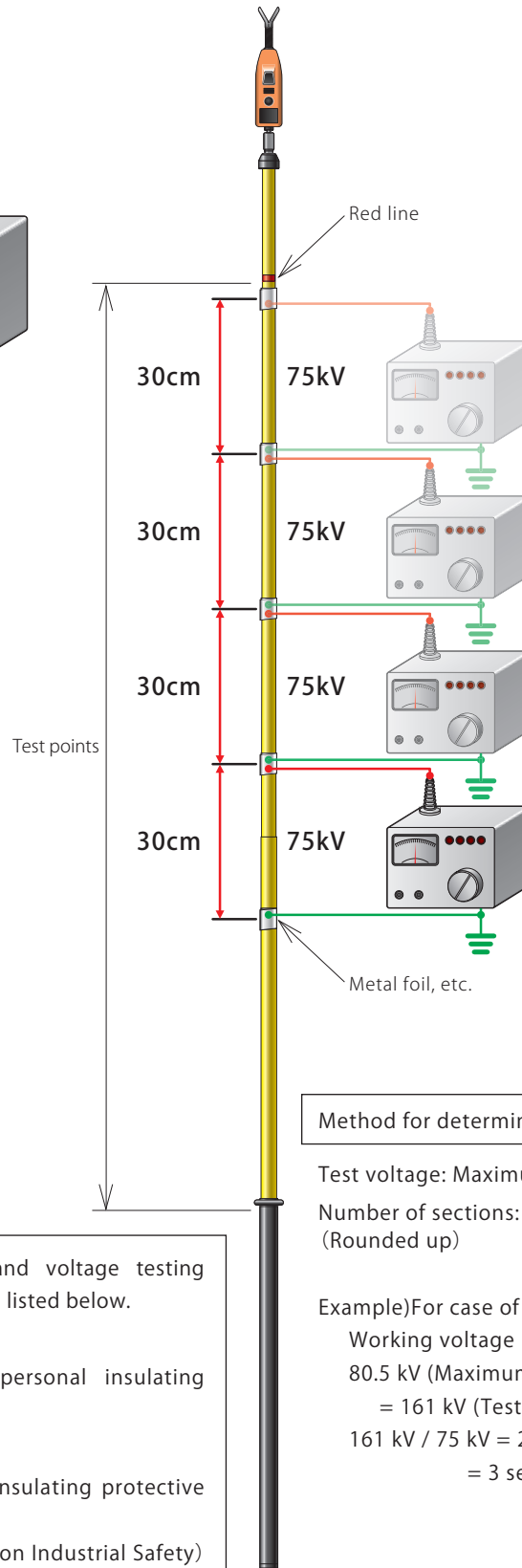

### Method for determining the number of sections

Test voltage: Maximum working voltage × 2

Number of sections: Test voltage / 75 kV  
(Rounded up)

Example) For case of HST-70

Working voltage range: 20 kV to 80.5 kV  
80.5 kV (Maximum working voltage) × 2  
= 161 kV (Test voltage)

161 kV / 75 kV = 2.15 (Number of sections)  
= 3 sections (rounded up)

Hasegawa Electric has defined the withstand voltage testing methods by quoting the regulations and others listed below.

- March 28, 1961 LSB Notification No. 247  
“Regulations on the performance of personal insulating protective equipment”  
(Ministry of Health, Labour and Welfare)
- 4th Edition Test standards for personal insulating protective equipment, etc.  
(Issued by: The Expert Group of Expertise on Industrial Safety)
- JIS C 4510-1991 Hook bars for disconnecting switch operation

Index etc.
Voltage detector
Auxiliary device for voltage detection
Voltage detector checker
Phase tester
Grounding hook
Discone hook stick
Discharge stick
Measuring instrument
Illuminator
Railway products
Information materials

# Confirming dead-line work

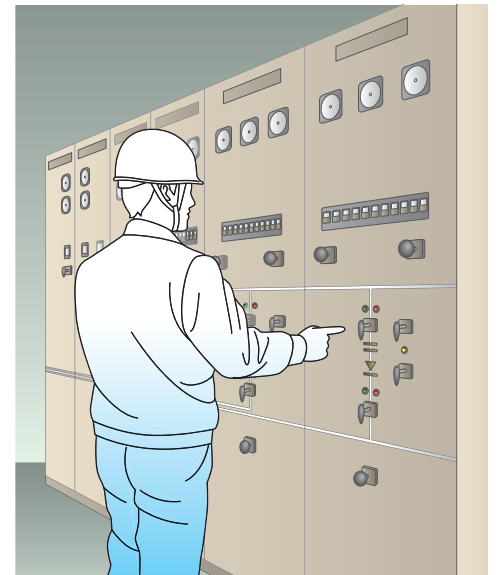

① Visual inspection of appearance and structure  
Battery check by pushing the test button

③ Turn off the Circuit Breaker  
Turn off the disconnect switch

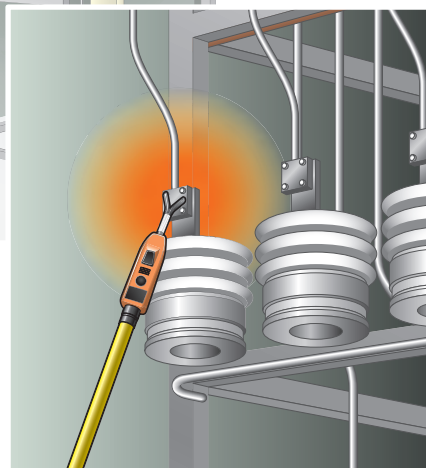
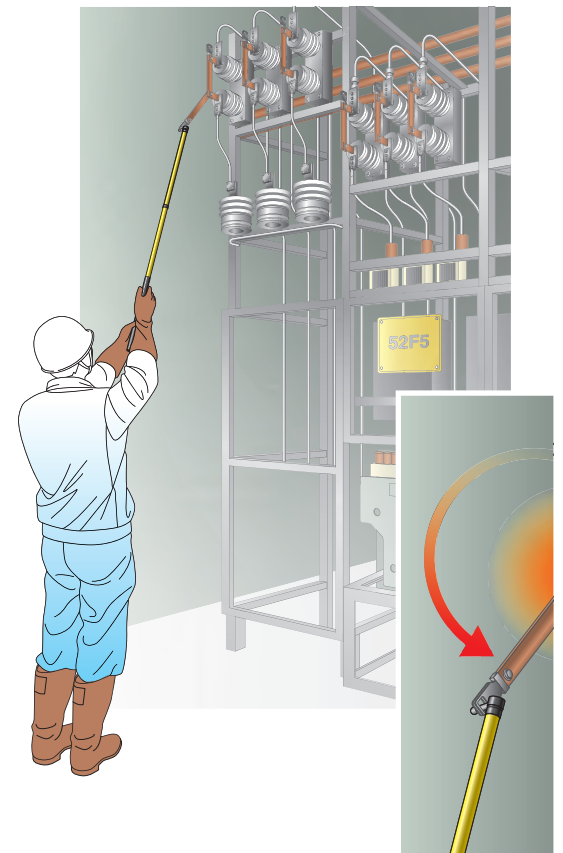
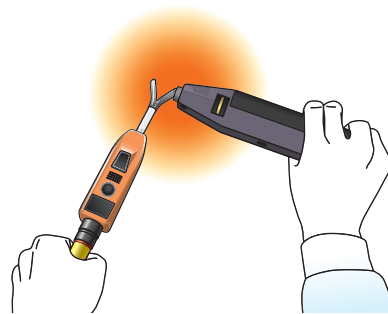
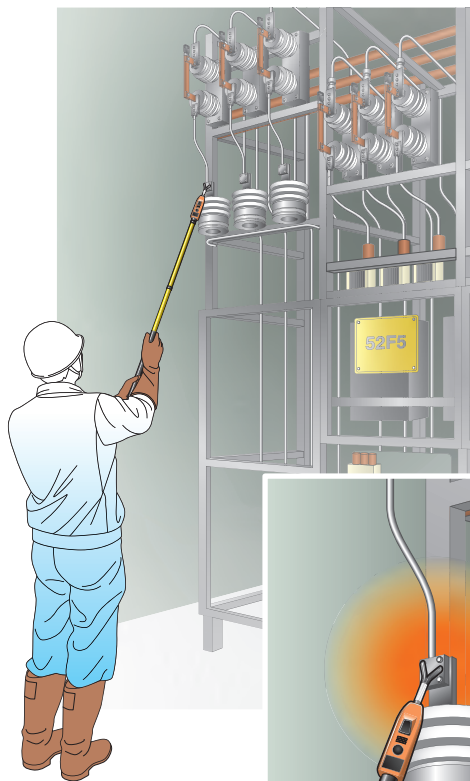

② Confirm normal operation of voltage detector contacting any charged conductor already known

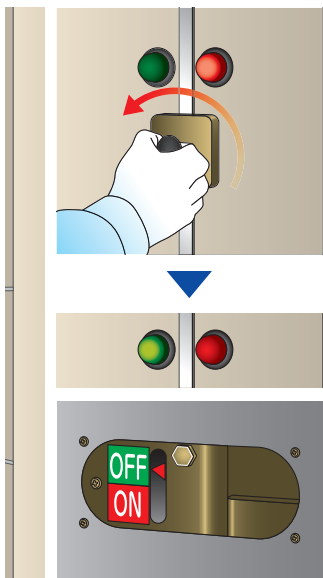

④ Bring the voltage detector into contact with Line 1, confirm the power is off.  
 Bring the voltage detector into contact with Line 2, confirm the power is off.  
 Bring the voltage detector into contact with Line 3, confirm the power is off.

\* Confirm all 3 lines

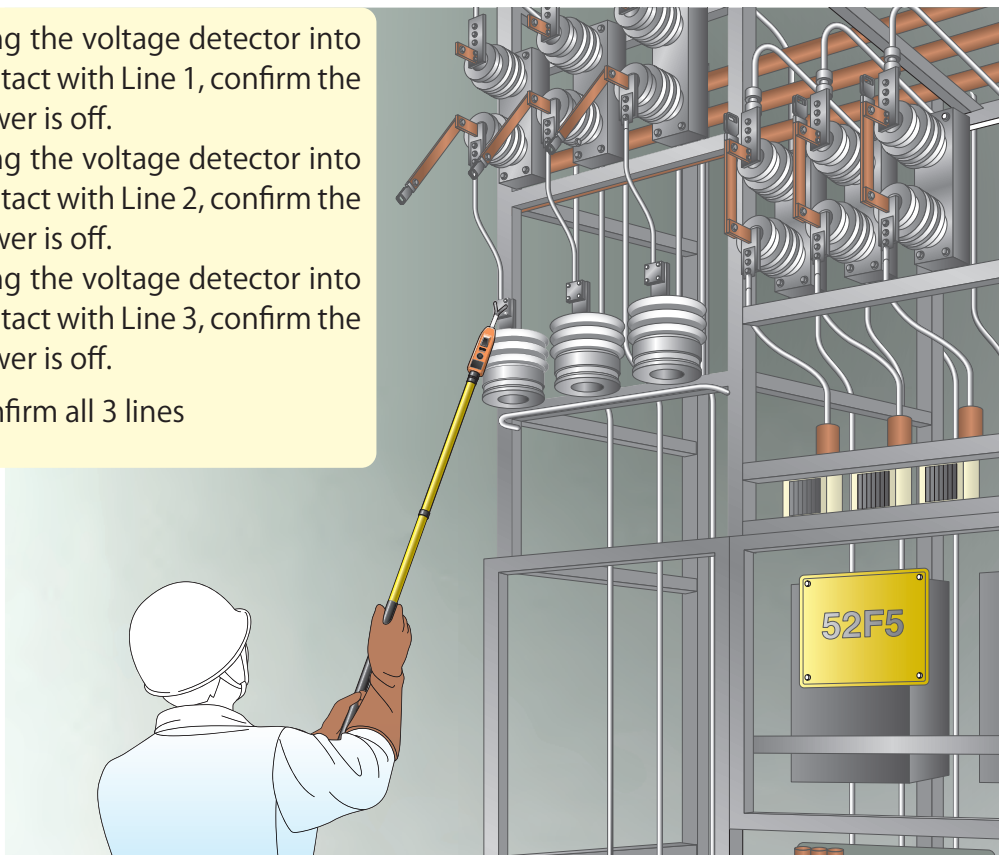

⑤ Visual check of grounding hook set.  
 Appearance and construction check

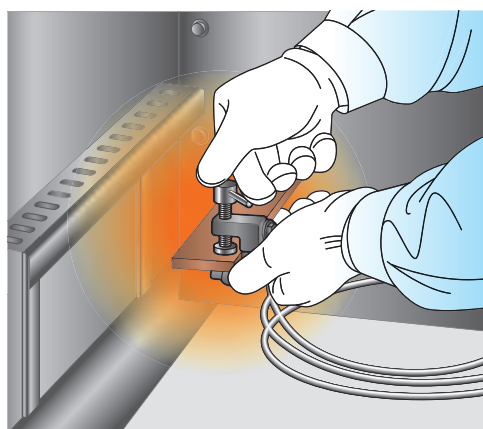
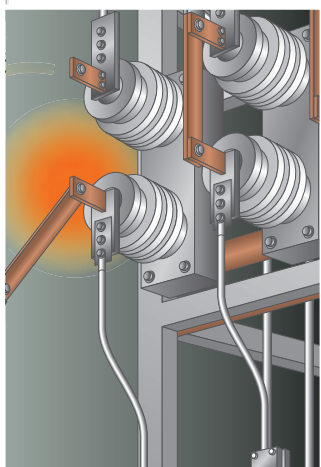
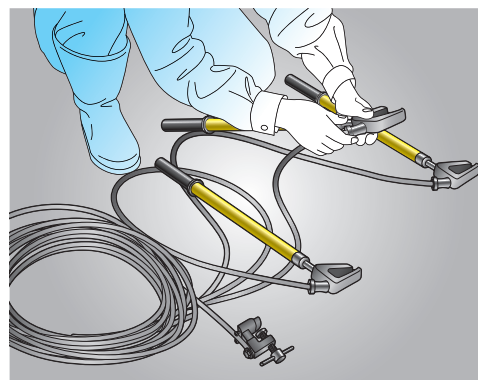

⑥ Connect the grounding device to earth terminal

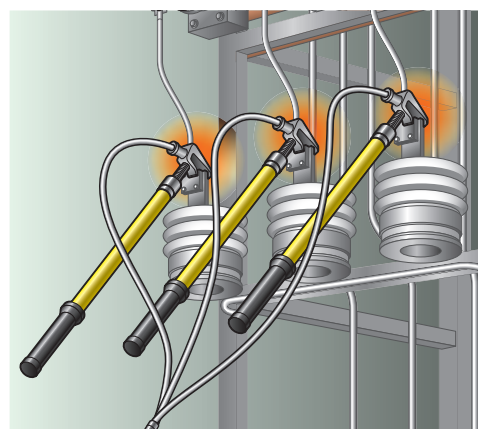

⑦ Connect the contact clamp to Line 1  
 Connect the contact clamp to Line 2  
 Connect the contact clamp to Line 3  
 \* Connect all 3 lines

Index etc.

Voltage detector

Auxiliary device for voltage detection

Voltage detector checker

Phase tester

Grounding hook

Discone hook stick

Discharge stick

Measuring instrument

Illuminator

Railway products

Information materials

# Introduction to the General Catalog of Relays

A separate volume with a blue front cover is provided as the general catalog of ground fault protection relays for AC and DC.

## ■ Contents

- Ground fault protection relay for AC
- Zero phase current transformer
- Transformer for ground mode measuring instrument
- Ground fault protection relay for DC
- Ground fault current transformer for DC
- DC ground fault protection relay



■ DC ground fault protection relay for quick chargers of electric vehicles (Conforming to CHAdeMO standard)



■ Plug-in type DC ground fault protection relay  
■ DC ground fault current transformer



■ DC circuit breaker for wiring with direct current leakage alarm



■ Plug-in type AC current leakage relay



■  $\omega$ C measurement type digital ground fault protection relay



